

SORTIMENT 2019 - 2020



AUTOMOTIVE LIGHTING SYSTEMS

FUSES | RELAYS | HORNS



Germany



We about us

FLÖSSER products – Made in Quality – not just words, but a dedication.

From our home town Trier/Germany we have been supplying automotive lighting products related to the safety of driving for over 60 years: bulbs for cars, motor-cycles, trucks and buses, fuses, relays and also signal horns.

Not only is FLÖSSER known for high quality products, but also for providing customised service. Personal assistance, short delivery times and economical ways of transport are what we can offer besides our products to meet your demands.

We about us:

OE and aftermarket customers in and outside of Europe have made us grow to our actual size:

representations in over 40 countries, customers in more than 90 countries, a local distribution center in the USA.

This new catalogue shows you the enlarged range of our products and we trust that you will find enough interesting products to enlighten your business.

FLÖSSER – Made in Quality







Index

Car bulbs

10 - 13	Xenon bulbs
14 - 33	Halogen bulbs
34 - 55	Conventional bulbs
56 - 57	48V, 58V & 80V
58 - 61	Hiperclick
62 - 69	Upgrade bulbs
70 - 75	LEDs
76 - 79	Blister program

Fuses

80 - 103	Various fuses
----------	---------------

Relays and flashers

104 - 114	Mini relays
115	Micro relais
116 - 117	Batterie relais
118 - 119	Destelladores

Signal horns

120 - 125	Disc and fanfare horns
-----------	------------------------

Accessories

126 - 129	Accessories
130 - 133	Bulb holders
134	Mini relay sockets
135 - 136	Spare lamp kits
137	Workshop kit
138 - 143	Fuse Kit
144 - 145	Sales display

Product index

146 - 188	Product index
-----------	---------------

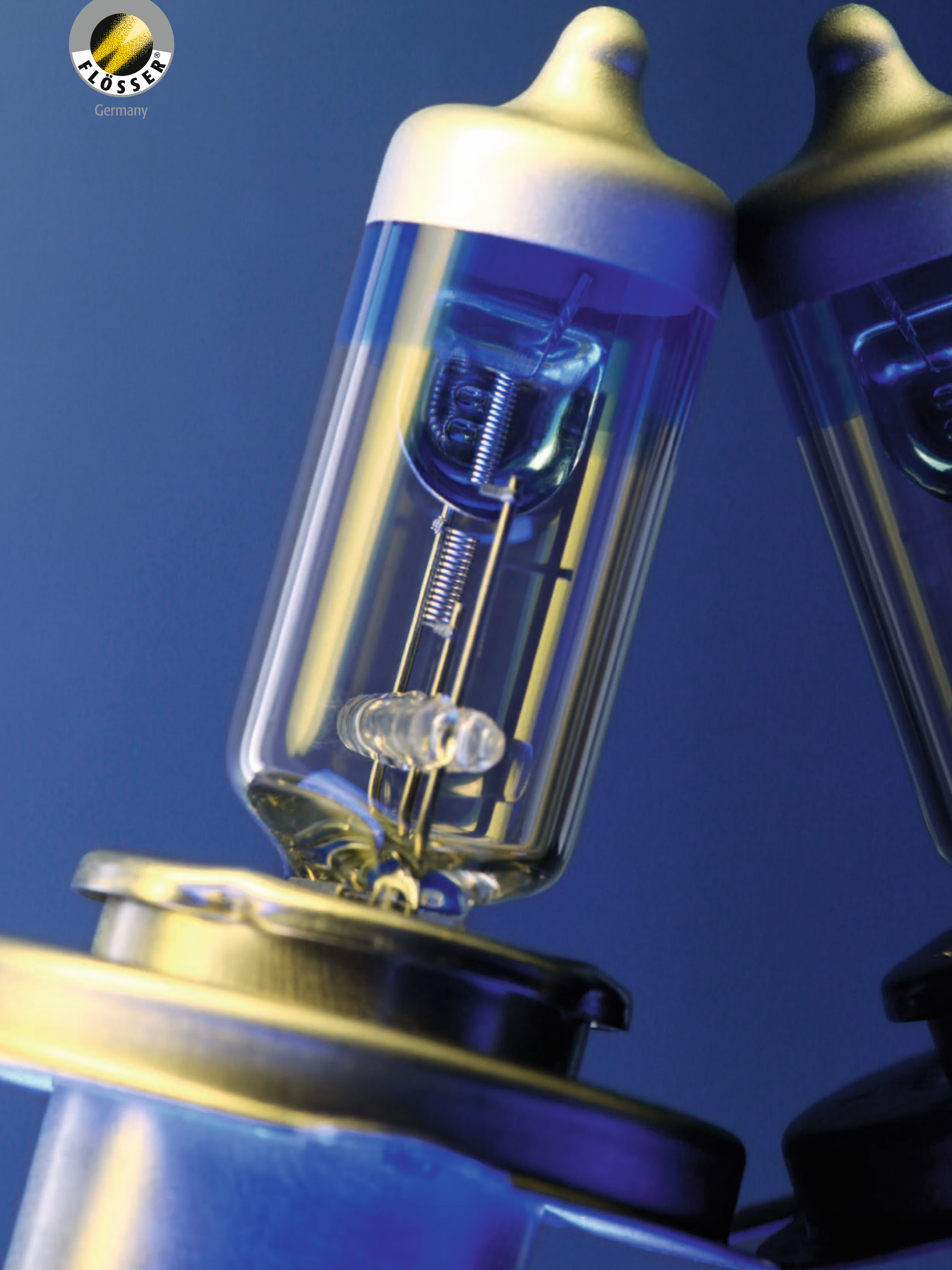





glossary

V	Volt
W	Watt
	Base
i	Designation
	packaging unit
	shipping unit
A	Ampere
ECE	Harmonized by ECE regulation
lm	Lumen
B3	time of failure for 3% of all tested bulbs
Tc	time of failure for 63,2% of all tested bulbs
	Lifetime
P.	Page





Car bulbs

Type	V	W		i		
85410	85	35	PK32d-2	D1S 4200°K	1	10
85510	85	35	PK32d-2	D1S Mega 5000°K	1	10
42322	42	35	PK32d-5	D3S Quecksilber frei mercury free	1	10
42522	42	35	PK32d-5	D3S Mega 5000°K mercury free	1	10
85409	85	35	PK32d-3	D1R 4200°K	1	10
42326	42	35	PK32d-6	D3R Quecksilber frei mercury free	1	10
85422	85	35	P32d-2	D2S 4200°K	1	10
85522	85	35	P32d-2	D2S Mega 5000°K	1	10
42422	42	35	P32d-5	D4S Quecksilber frei mercury free	1	10

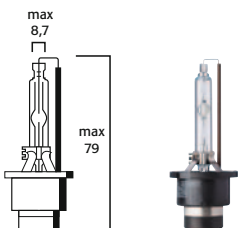
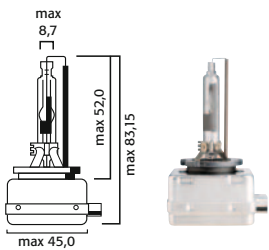
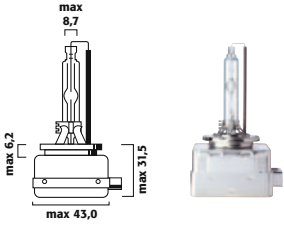



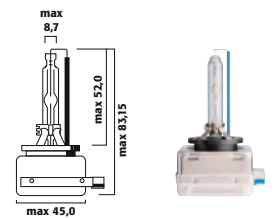
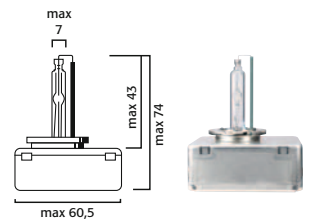
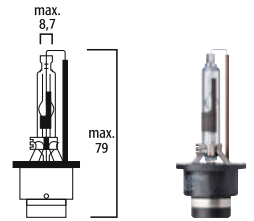

Type	V	W		i		
85426	85	35	P32d-3	D2R 4200°K	1	10
85526	85	35	P32d-3	D2R Mega 5000°K	1	10
42426	42	35	P32d-6	D4R Quecksilber frei mercury free	1	10
40722	12	25	PK32d-7	D5S 4200°K	1	1
40822	42	25	PK32d-1	D8S Quecksilber frei mercury free	1	1







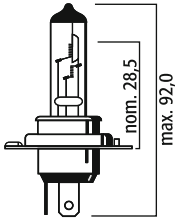

Halogen headlight bulbs

Standard types

Type	V	W		i		
625543	12	60/55	P43t	H4	10	100
9625543	12	60/55	P43t	H4 Blister	1	18
9003	12	60/55	P43t	H4 USA (HB2-DOT approved)	10	100
825543	24	75/70	P43t	H4	10	100
625522	12	60/55	P43t	H4 Longlife	10	100
825522	24	75/70	P43t	H4 VR LL (Vibration Resistant & Longlife)	10	100
6255333	12	60/55	P43t	H4 Megablau · megablue	10	100
9003333	12	60/55	P43t	H4 USA Blau · blue (HB2-DOT approved)	10	100
6230043	12	60/55	P43t	H4 Ultra White 4200°K +30%	10	100
96230043	12	60/55	P43t	H4 Ultra White 4200°K +30% · blister	1	18
6255600	12	60/55	P43t	H4 Ultra White 4200°K +30% · twinbox	1	20
6289043	12	60/55	P43t	H4 Megaplug 50%	10	100
6255680	12	60/55	P43t	H4 Megaplug 50% Doppelbox · twinbox	1	20
6290043	12	60/55	P43t	H4 Ultra +90%	10	100
96290043	12	60/55	P43t	H4 Ultra +90% · blister	1	18
6255180	12	60/55	P43t	H4 Ultra +90% Doppelbox · twinbox	1	20



Special types

Type	V	W		i		
525543	12	100/55	P43t	H4 Rally	10	100
725543	12	100/90	P43t	H4 Rally	10	100
9725543	12	100/90	P43t	H4 Rally Blister	1	18
7255333	12	100/90	P43t	H4 Rally Megablau	10	100
7255335	12	100/90	P43t	H4 Silberblau · silverblue	10	100
7255670	12	100/90	P43t	H4 Silberblau Doppelbox silverblue twinbox	1	20
925543	12	130/90	P43t	H4 Super Rally	10	100
9210043	12	130/100	P43t	H4 Super Rally	10	100
92145	12	145/100	P43t	H4 Super Rally	10	100
9214533	12	145/100	P43t	H4 Super Rally Blau · blue	10	100
8290043	24	100/90	P43t	H4 Rally	10	100
8213043	24	130/90	P43t	H4 Super Rally	10	100

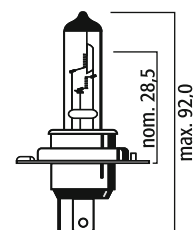





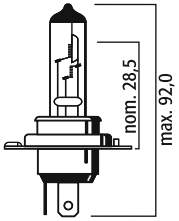

Halogen headlight bulbs

Non-standard types

Type	V	W		i		
625545	12	60/55	P45t	H4	10	100
825545	24	75/70	P45t	H4	10	100
725545	12	100/90	P45t	H4 Rally	10	100
925545	12	130/90	P45t	H4 Super Rally	10	100
8290045	24	100/90	P45t	H4 Rally	10	100
625536	12	60/55	P36t	H4 old type	10	100



H1 Bulbs

Type	V	W		i		
3021	12	55	P14,5s	H1	10	100
93021	12	55	P14,5s	H1 Blister	1	42
3024	24	70	P14,5s	H1	10	100
302122	12	55	P14,5s	H1 Longlife	10	100
302422	24	70	P14,5s	H1 VR LL (Vibration Resistant & Longlife)	10	100
3021333	12	55	P14,5s	H1 Megablau · megablue	10	100
3021300	12	55	P14,5s	H1 Ultra White 4200°K +30%	10	100
93021300	12	55	P14,5s	H1 Ultra White 4200°K +30% · blister	1	42
3021600	12	55	P14,5s	H1 Ultra White 4200°K +30% · twinbox	1	10
3021890	12	55	P14,5s	H1 Megaplust 50%	10	100
3021680	12	55	P14,5s	H1 Megaplust 50% Doppelbox · twinbox	1	10
3021900	12	55	P14,5s	H1 Ultra +90%	10	100
93021900	12	55	P14,5s	H1 Ultra +90% · blister		
3021180	12	55	P14,5s	H1 Ultra +90% Doppelbox · twinbox	1	10

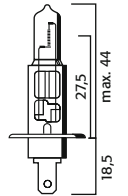



Halogen headlight bulbs

H1 Bulbs

Type	V	W		i		
3021335	12	70	P14,5s	H1 4300°K Silberblau · silverblue	10	100
3021670	12	70	P14,5s	H1 Silberblau Doppelbox silverblue twinbox	1	10
13020	12	100	P14,5s	H1 Rally	10	100
13130	12	130	P14,5s	H1 Super Rally	10	100
13024	24	100	P14,5s	H1 Rally	10	100

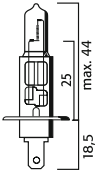

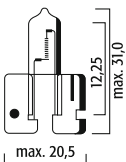

H2 Bulbs

Type	V	W		i		
3720	24	70	X511	H2	10	200



H3 Bulbs

Type	V	W		i		
3320	12	55	PK22s	H3	10	100
93320	12	55	PK22s	H3 Blister	1	36
3324	24	70	PK22s	H3	10	100
332422	24	70	PK22s	H3 VRLL (Vibration Resistant & Longlife)	10	100
3320333	12	55	PK22s	H3 Megablau · megablue	10	100
3320666	12	55	PK22s	H3 Semigold	10	100
3320900	12	55	PK22s	H3 Ultra +90%	10	100
93320900	12	55	PK22s	H3 Ultra +90% Blister	1	36
3320335	12	70	PK22s	H3 Silberblau · silverblue	10	100
13320	12	100	PK22s	H3 Rally	10	100
13330	12	130	PK22s	H3 Super Rally	10	100
13324	24	100	PK22s	H3 Rally	10	100
1332033	12	100	PK22s	H3 Rally Blau · blue	10	100
3348	48	45	PK22s	H3	10	100
3380	80	55	PK22s	H3	10	100

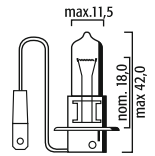

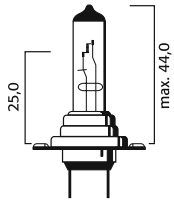

H7 Bulbs



Type	V	W		i		
2070	12	55	PX26d	H7	10	100
92070	12	55	PX26d	H7 Blister	1	24
2470	24	70	PX26d	H7	10	100
207022	12	55	PX26d	H7 Longlife	10	100
247022	24	70	PX26d	H7 VR LL (Vibration Resistant & Longlife)	10	100
2070333	12	55	PX26d	H7 Megablau · megablue	10	100
2070300	12	55	PX26d	H7 Ultra White 4200°K +30%	10	100
92070300	12	55	PX26d	H7 Ultra White 4200°K +30% · blister	1	24
2070600	12	55	PX26d	H7 Ultra White 4200°K +30% Doppelbox · twinbox	1	10
2070890	12	55	PX26d	H7 Megaplug 50%	10	100
2070680	12	55	PX26d	H7 Megaplug 50% Doppelbox · twinbox	1	10
2070900	12	55	PX26d	H7 Ultra +90%	10	100
92070900	12	55	PX26d	H7 Ultra +90% Blister	1	24
2070180	12	55	PX26d	H7 Ultra +90% Doppelbox · twinbox	1	10
2070100	12	55	PX26d	H7 Ultra +100%	10	100

H7 Bulbs

Type	V	W		i		
2070335	12	70	PX26d	H7 Silberblau · silverblue	10	100
2070670	12	70	PX26d	H7 Silberblau Doppelbox silverblue twinbox	1	10
12070	12	80	PX26d	H7 Rally	10	100



H8 Bulbs

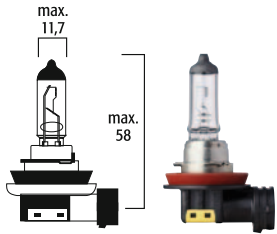

Type	V	W		i		
2080	12	35	PGJ19-1	H8	10	100
92080	12	35	PGJ19-1	H8 Blister	1	27



2080335	12	50	PGJ19-1	H8 Silberblau · silverblue	10	100
---------	----	----	---------	----------------------------	----	-----

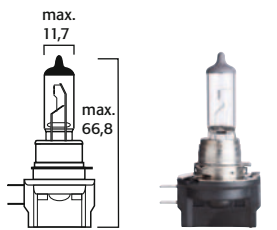



12080	12	80	PGJ19-1	H8 Rally	10	100
-------	----	----	---------	----------	----	-----

2080B	12	35	PGJY19-1	H8B gerader Sockel straight socket culot droit · base recta	1	100
-------	----	----	----------	---	---	-----

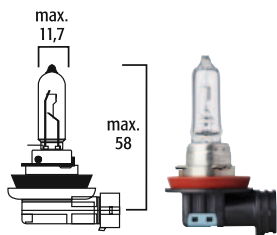
H9 Bulbs



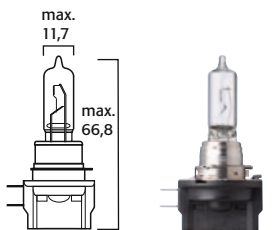

Type	V	W		i		
2090	12	65	PGJ19-5	H9	10	100
92090	12	65	PGJ19-5	H9 Blister	1	27



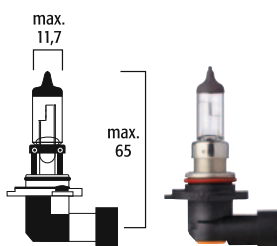

2090B	12	65	PGJY19-5	H9B gerader Sockel straight socket culot droit · base recta	10	100
-------	----	----	----------	---	----	-----



H10 Bulbs



Type	V	W		i		
9145	12	42	PY20d	H10	10	100

H11 Bulbs

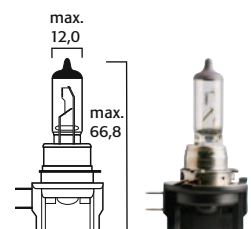
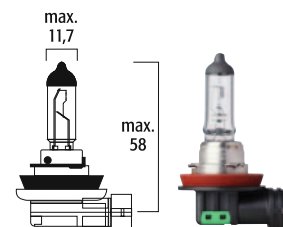
Type	V	W		i		
2110	12	55	PGJ19-2	H11	10	100
92110	12	55	PGJ19-2	H11 Blister	1	27
2114	24	70	PGJ19-2	H11	10	100
211022	12	55	PGJ19-2	H11 Longlife	10	100
2110333	12	55	PGJ19-2	H11 Megablau megablue	10	100
2110900	12	55	PGJ19-2	H11 Ultra +90%	10	100
92110900	12	55	PGJ19-2	H11 Ultra +90% Blister	1	27
2110335	12	70	PGJ19-2	H11 Silberblau · silverblue	10	100
12110	12	90	PGJ19-2	H11 Rally	10	100
2110B	12	55	PGJY19-2	H11B gerader Sockel straight socket culot droit · base recta	10	100



H12 Bulbs

Type	V	W		i		
9055	12	53	PZ20d	H12	10	100

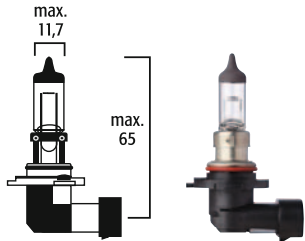

H13 Bulbs

Type	V	W		i		
9008	12	60/55	P26,4t	H13	10	100
9008333	12	60/55	P26,4t	H13 Blau · blue	10	100
9108	12	100/80	P26,4t	H13 Rally	10	100

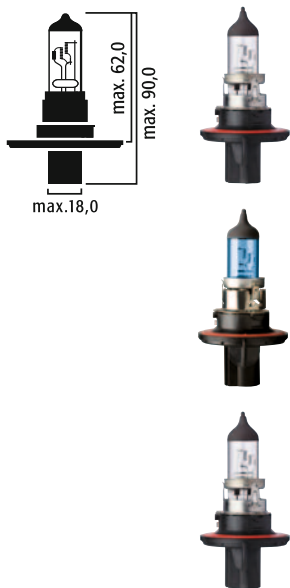

H15 Bulbs

Type	V	W		i		
551523	12	55/15	PGJ23t-1	H15	10	100
602023	24	60/20	PGJ23t-1	H15	10	100

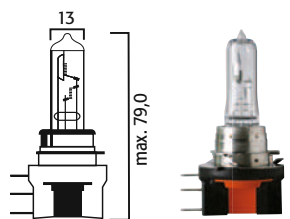

H16 Bulbs

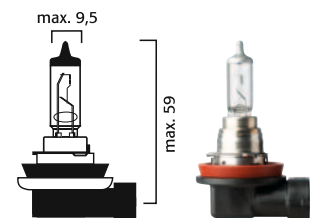

Type	V	W		i		
191219	12	19	PGJ19-3	H16 Longlife	10	100



Halogen headlight bulbs with plastic base



American types

Type	V	W		i		
9004	12	65/45	P29t	HB1	10	100
99004	12	65/45	P29t	Blister	1	21
9004333	12	65/45	P29t	HB1 Blau · blue	10	100
9004777	12	65/45	P29t	HB1 Gold	10	100
9004100	12	65/45	P29t	HB1 Ultra +100%	10	100
9104	12	100/80	P29t	HB1 Rally	10	100
9104333	12	100/80	P29t	HB1 Rally Blau · blue	10	100





Halogen headlight bulbs with plastic base

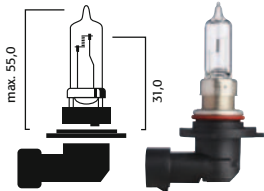

HB3 Bulbs

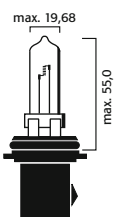

Type	V	W		i		
9005	12	60	P20d	HB3	10	100
99005	12	60	P20d	Blister	1	24
9005333	12	60	P20d	HB3 Megablau megablue	10	100
9005900	12	60	P20d	HB3 Ultra +90%	10	100
99005900	12	60	P20d	Blister	1	24
9105	12	100	P20d	HB3 Rally	10	100
9005XS	12	60	PX20d	HB3A gerader Sockel straight socket culot droit · base recta	10	120



HB4 Bulbs

Type	V	W		i		
9006	12	51	P22d	HB4	10	100
99006	12	51	P22d	Blister	1	24
9006333	12	51	P22d	HB4 Megablau megablue	10	100
9006900	12	51	P22d	HB4 Ultra +90%	10	100
99006900	12	51	P22d	Blister	1	24
9076	12	70	P22d	HB4 Rally	10	100
9086	12	80	P22d	HB4 Super Rally	10	100
9006335	12	60	P22d	HB4 Silberblau · silverblue	10	100
9006XS	12	51	P22d	HB4 gerader Sockel straight socket culot droit · base recta	10	120

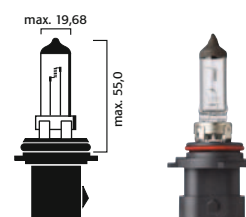
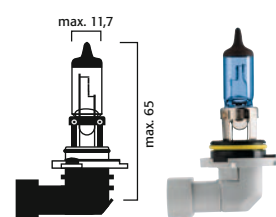
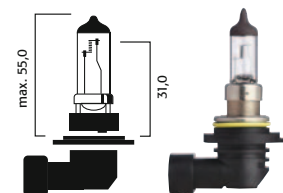

HB5 Bulbs

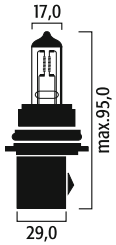

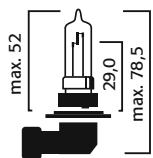
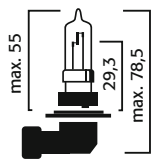

Type	V	W		i		
9007	12	65/55	PX29t	HB5	10	100
99007	12	65/55	PX29t	HB5 Blister	1	21
9007333	12	65/55	PX29t	HB5 Blau · blue	10	100
9107	12	100/80	PX29t	HB5 Rally	10	100

HIR Bulbs









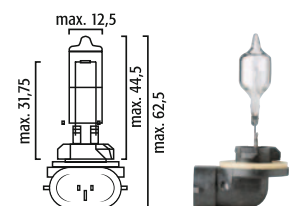
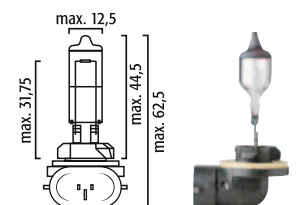
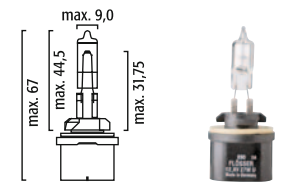
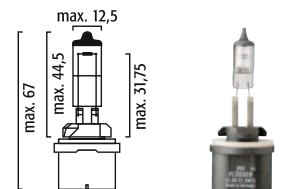
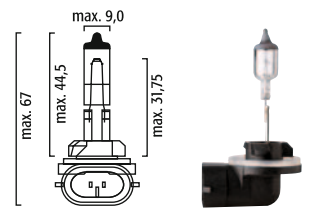
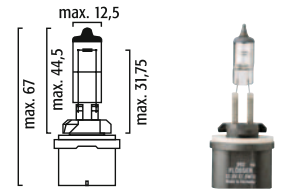

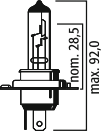

Type	V	W		i		
9011	12	65	PX20d	HIR1 Halogen Infrarot · infrared	10	100
9012	12	55	PX22d	HIR2 Halogen Infrarot · infrared	10	100

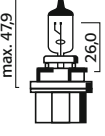
H27W Bulbs

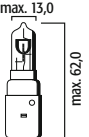

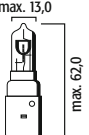
Type	V	W		i		
880	12	27	PG13	H27W/1	10	100
881	12	27	PGJ13	H27W/2	10	100
893	12	37,5	PG13		10	100
885	12	50	PG13	Keine schwarze Kappe no black cap	10	100
890	12	27	PG13	Keine schwarze Kappe no black cap	10	100
896	12	37,5	PGJ13		10	100
886	12	50	PGJ13	Keine schwarze Kappe no black cap	10	100
894	12	37,5	PGJ13	Keine schwarze Kappe no black cap	10	100



Type	V	W		i		
 	12	35/35	PX43t	HS1	10	100
	12	35/35	PX43t	HS1 blau · blue	10	100
 	12	35/30	P23t	HS5	10	100
 	12	25/25	BA20d	Halogen	10	200
	12	35/35	BA20d	Halogen	10	200
 	12	35/35	BA20d	Halogen Blau · blue	10	200
	12	35/35	BA20d	S2 Halogen	10	200



Halogen bulbs for two-wheelers

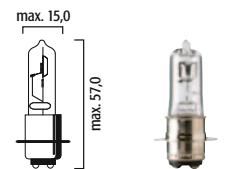
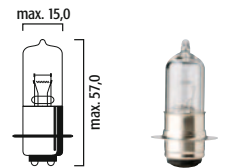
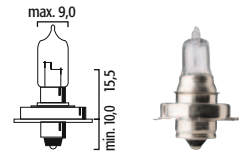

Type	V	W		i		
2015	12	15	P26s	S3 Halogen	10	300
2251	12	25/25	P15d-25-1	M5	10	100
2351	12	35/35	P15d-25-1	M5	10	100
2353	12	35/35	P15d-25-3	M5	10	100
225112	12	25/25	P15d-25-1	M5 mit Abblendkappe with cap	10	100
235112	12	35/35	P15d-25-1	M5 mit Abblendkappe with cap	10	100
235312	12	35/35	P15d-15-3	M5 mit Abblendkappe with cap	10	200

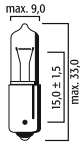



Type	V	W		i		
4005	12	5	BA9s		10	200
4010	12	10	BA9s		10	200
4020	12	20	BA9s		10	200
4006	12	6	BAX9s	H6W	10	200
400633	12	6	BAX9s	H6W Blau · blue	10	200
400601	12	6	BAZ9s	HY6W Amber	10	200
6021	12	21	BAY9s	H21W	10	200
602101	12	21	BAW9s	HY21W · Amber	10	200
6421	24	21	BAY9s	H21W	10	200

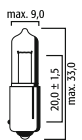
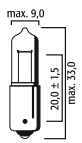
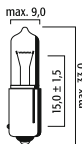
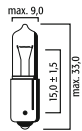

Miniature halogen bulbs



Type	V	W		i		
4891	12	5	W2,1x9,5d	W5W	10	200
489133	12	5	W2,1x9,5d	W5W Blau · blue	10	100
2074205	12	5	G4		10	100
2074210	12	10	G4		10	100
2074220	12	20	G4		10	100
2074410	24	10	G4		10	100
2074420	24	20	G4		10	100
795X	12	50	BA15s	Halogen	10	100

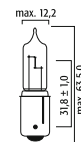
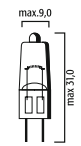
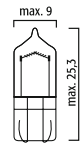

Headlight bulbs

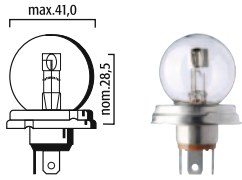

Type	V	W		i		
3130	6	45/40	P45t	R2	10	100
3940	12	45/40	P45t	R2	10	100
3770	24	55/50	P45t	R2	10	100
394002	12	75/75 CP	P45t		10	100
377002	24	75/75 CP	P45t		10	100

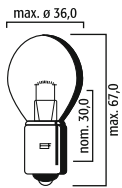

3329	12	35	BA20s	F2	10	200
3350	12	50	BA20s		10	200
3440	24	35	BA20s	F2	10	200

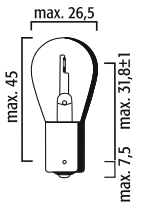

5338	12	25	BA15s		10	200
6640	24	45	BA15s	Form U	10	200

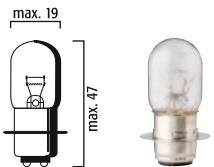

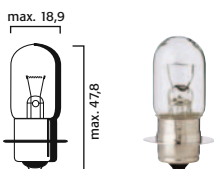

6251	6	25/25	P15d-25-1		10	100
1181	12	18/18	P15d-25-1		10	100
1251	12	25/25	P15d-25-1		10	100



1351	12	35/35	P15d-25-1		10	100
1151	12	25	P15s-25-1		10	100

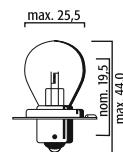
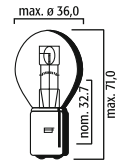

Headlight bulbs for two-wheelers

Type	V	W		i		
3265	6	15/15	BA20d		10	200
3223	6	25/25	BA20d	S1	10	200
3131	6	35/35	BA20d	S2	10	200
3923	12	25/25	BA20d	S1	10	200
3939	12	35/35	BA20d	S2	10	200
93939	12	35/35	BA20d	Blister	1	24
24540	12	45/40	BA20d		10	200
6743	24	45/40	BA20d		10	200
6000	6	15	P26s	S3	10	100
2000	12	15	P26s	S3	10	100
200033	12	15	P26s	Blau · blue	10	100
4000	24	15	P26s		10	100
2001	12	20	P26s		10	100
2002	12	25	P26s		10	100



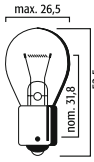

Stop and flashing lights



Type	V	W		i		
6670	6	21	BA15s	P21W	10	200
6671	12	21	BA15s	P21W 1141	10	200
96671	12	21	BA15s	P21W Blister	1	33
6652	24	21	BA15s	P21W	10	200
665299	24	21	BA15s	P21W Heavy Duty	10	200



Type	V	W		i		
667107	12	21	BA15s	Amber	10	200
667133	12	21	BA15s	Blau · blue	10	200
665207	24	21	BA15s	Amber	10	200
665208	24	21	BA15s	Rot · red	10	200
8671	12	25	BA15s	1073	10	200
8652	24	25	BA15s		10	200

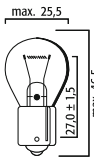

5671	12	15	BA15s	93	10	200
5652	24	15	BA15s		10	200
4670	6	18	BA15s		10	200
4671	12	18	BA15s		10	200
4652	24	18	BA15s		10	200



Stop and flashing lights

Type	V	W		i		
667101	12	21	BAU15s	PY21W Amber	10	200
9667101	12	21	BAU15s	PY21W Amber Blister	1	33
6671SV	12	21	BAU15s	PY21W Silber · silver	10	200
665201	24	21	BAU15s	PY21W Amber	10	200

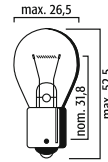

Type	V	W		i		
6678	12	21	BAU15s	Klar · clear	10	200

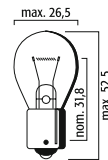

Type	V	W		i		
6674	12	21	BA15d	1142	10	200
6654	24	21	BA15d		10	200

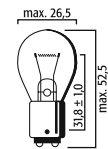

Type	V	W		i		
667102	12	21	BAW15s	PR21W Rot · red	10	200

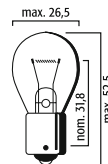

Type	V	W		i		
3156	12	27	W2,5x16d	P27W	10	500
93156	12	27	W2,5x16d	P27W Blister	1	33
315601	12	27	W2,5x16d	Amber	10	500

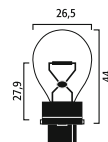

Conventional bulbs

Stop and taillamp bulbs

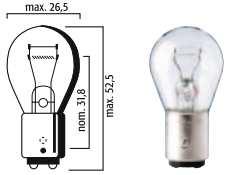

Type	V	W		i		
5228	6	21/5	BAY15d	P21/5W	1154	10 200
5229	12	21/5	BAY15d	P21/5W	1016	10 200
95229	12	21/5	BAY15d	P21/5W Blister		1 33
5239	24	21/5	BAY15d	P21/5W		10 200

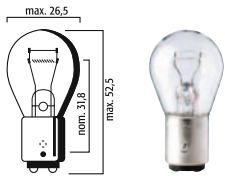

Type	V	W		i		
5226	6	10/3	BAY15d		10	200
5227	12	10/5	BAY15d		10	200
5230	12	32/4 CP	BAY15d	1034	10	200
5209	12	18/5	BAY15d		10	200
5249	24	25/5	BAY15d		10	200
9629	48	25/10	BAY15d		10	200
522907	12	21/5	BAY15d	Amber	10	200
523908	24	21/5	BAY15d	Rot · red	10	200



Stop and taillamp bulbs

Type	V	W		i		
5219	12	21/5	BA15d	1176	10	200
5238	24	21/5	BA15d		10	200

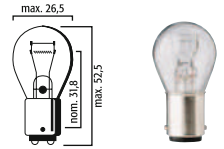

Type	V	W		i		
522902	12	21/5	BAW15d	PR21/5W Rot · red	10	200

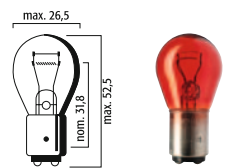

Type	V	W		i		
5329	12	21/4	BAZ15d	P21/4W	10	200
5339	24	21/4	BAZ15d	P21/4W	10	200

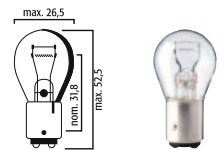

Type	V	W		i		
3157	12	27/7	W2,5x16q	P27/7W	10	500
93157	12	27/7	W2,5x16q	P27/7W Blister	1	33
315701	12	27/7	WX2,5x16q	PY27/7W Amber 3157NA	10	500
3057	12,8	32/2 CP	W2,5x16q		10	500
375701	12,8	2,1/0,59 A	WX2,5x16q	3757NA	10	500

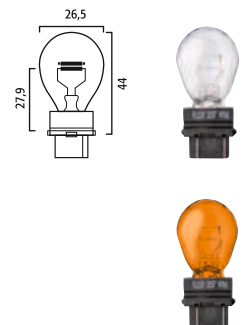

Taillamp bulbs

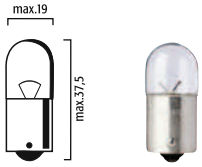

Type	V	W		i		
4023	6	5	BA15s	R5W	10	200
4025	12	5	BA15s	R5W	67	200
94025	12	5	BA15s	R5W Blister	1	51
4052	24	5	BA15s	R5W	10	200
405299	24	5	BA15s	R5W Heavy Duty	10	200

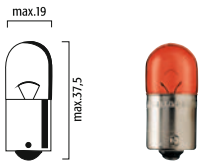

Type	V	W		i		
402509	12	5	BA15s	Rot · red	10	200
402533	12	5	BA15s	Blau · blue	10	200
405233	24	5	BA15s	Blau · blue	10	200

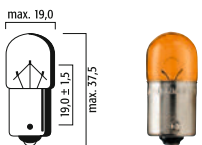

1402507	12	10	BA15s	Amber	10	200
1402509	12	10	BA15s	Rot · red	10	200
1402533	12	10	BA15s	Blau · blue	10	200



Taillamp bulbs

Type	V	W		i		
14023	6	10	BA15s	R10W	10	200
14025	12	10	BA15s	R10W	10	200
914025	12	10	BA15s	R10W Blister	1	51
14052	24	10	BA15s	R10W	10	200
1405299	24	10	BA15s	R10W Heavy Duty	10	200

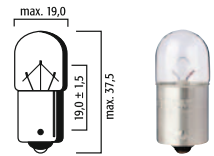

Type	V	W		i		
1402501	12	10	BAU 15s	RY10W Amber	10	200

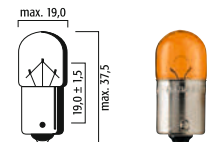

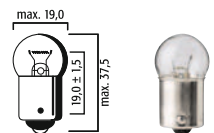

Type	V	W		i		
1421	12	3	BA15s		10	100
15025	12	15	BA15s		10	100
4071	12	21	BA15s		10	100

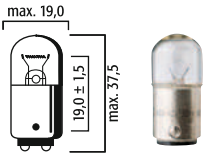

Indicator light bulbs



Type	V	W		i		
4425	12	5	BA15d	R5W	10	200
4452	24	5	BA15d	R5W	10	200
14425	12	10	BA15d	R10W	10	100
14452	24	10	BA15d	R10W	10	100

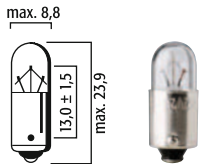

Type	V	W		i		
4039	6	2	BA9s		10	100
4038	12	2	BA9s	53	10	200
3038	12	3	BA9s		10	200
4008	24	2	BA9s		10	200
3008	24	3	BA9s		10	200

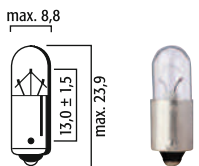

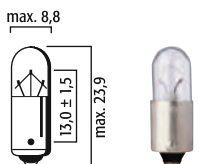

Type	V	W		i		
4089	6	4	BA9s	T4W	10	200
4088	12	4	BA9s	T4W	10	200
94088	12	4	BA9s	T4W Blister	1	75





4080	24	4	BA9s	T4W	10	200
408099	24	4	BA9s	T4W Heavy Duty	10	200

With base BA9s

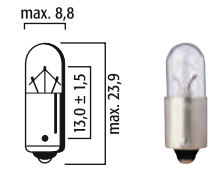
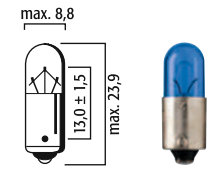
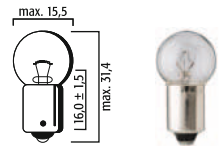
Type	V	W		Type	i		
2038	12	4	BA9s	57		10	200
408835	12	4	BA9s	Dunkelblau · dark blue		10	100
408035	24	4	BA9s	Dunkelblau · dark blue		10	100
4085	12	5	BA9s			10	100



With base BA7s

Type	V	W		Type	i		
4049	6	0,6	BA7s			10	100
4050	6	1,2	BA7s			10	200
4051	12	2	BA7s			10	200
4048	24	3	BA7s			10	200

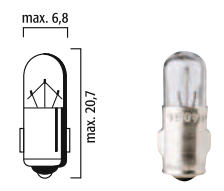



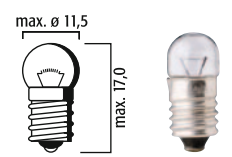

Min screw base

Type	V	W		Type	i		
4043	6	2	E10			25	500
4045	12	3	E10			10	100
4046	24	3	E10			10	100

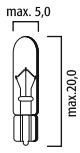

With glass base



Type	V	W		i		
4196	6	1,2	W2x4,6d	T5	10	100
4191	12	1,2	W2x4,6d	T5	74	10
94191	12	1,2	W2x4,6d	T5 Blister	1	75
419122	12	1,2	W2x4,6d	T5 Longlife	10	100
419106	12	1,2	W2x4,6d	T5 Matt · frosted	10	100
419116	12	30 mA	W2x4,6d	T5 Matt · frosted	10	100
419107	12	1,2	W2x4,6d	T5 Amber	10	100
419134	12	1,2	W2x4,6d	T5 Grün · green	10	100
4391	12	2	W2x4,6d	T5	10	100
4691	12	2,3	W2x4,6d	W2,3W	10	100
469101	12	2,3	W2x4,6d	WY2,3W Amber	10	100



With glass base

Type	V	W		i		
4590	12	3	W2x4,6d	T5	10	100
4192	24	1,2	W2x4,6d	T5	10	200
27140	24	30 mA	W2x4,6d	T5	10	100
27141	24	1	W2x4,6d	T5	10	100

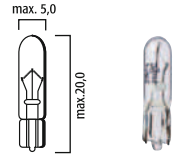

Type	V	W		i		
4591	12	3	W2x4,6d	T6,5	10	100

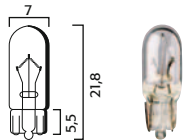

Type	V	W		i			
4090	12	3	W2,1x9,5d	W3W T10	158	10	200
4092	24	3	W2,1x9,5d	W3W T10	10	200	

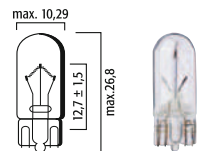

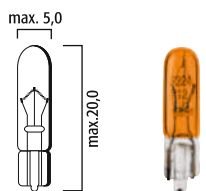
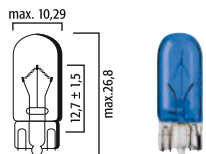

4291	12	5	W2,1x9,5d	W5W T10	10	200
94291	12	5	W2,1x9,5d	W5W T10 Blister	1	75
429122	12	5	W2,1x9,5d	W5W T10 Longlife	10	200
429133	12	5	W2,1x9,5d	W5W T10 Blau · blue	10	100
4292	24	5	W2,1x9,5d	W5W T10	10	200
429101	12	5	W2,1x9,5d	WY5W T10 Amber	10	100

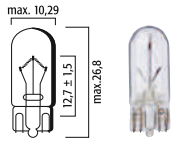

With glass base



Type	V	W		i		
4290	12	2	W2,1x9,5d	W2W T10	10	200

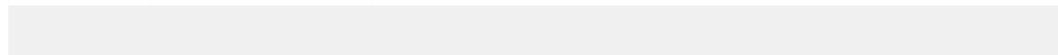

4096	6	3	W2,1x9,5d	W3W T10	10	100
------	---	---	-----------	---------	----	-----

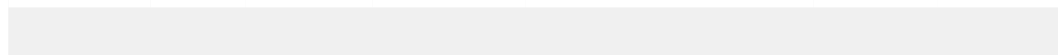

429209	24	5	W2,1x9,5d	T10 Rot · red	10	100
--------	----	---	-----------	---------------	----	-----



429234	24	5	W2,1x9,5d	T10 Grün · green	10	100
--------	----	---	-----------	------------------	----	-----



429235	24	5	W2,1x9,5d	T10 Dunkelblau · dark blue	10	100
--------	----	---	-----------	----------------------------	----	-----



Type	V	W		i		
------	---	---	---	---	---	---

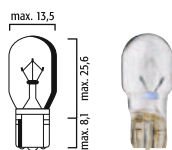

4496	6	10	W2,1x9,5d	T13	10	100
------	---	----	-----------	-----	----	-----

4490	12	10	W2,1x9,5d	T13	10	100
------	----	----	-----------	-----	----	-----

449007	12	10	W2,1x9,5d	T13 Amber	10	100
--------	----	----	-----------	-----------	----	-----





With glass base

Type	V	W		i		
921	12	16	W2,1x9,5d	W16W T15	10	200
9921	12	16	W2,1x9,5d	W16W T15 Blister	1	51
92107	12	16	W2,1x9,5d	T15 Amber	10	100
906	13	6 CP	W2,1x9,5d	T15	10	200

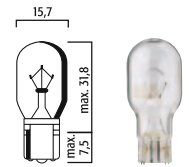

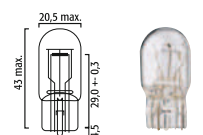
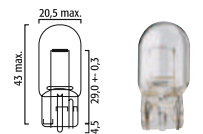

Type	V	W		i		
2190	12	21	W3x16d	W21W T20	10	700
219007	12	21	WX3x16d	WY21W Amber T20	10	700
2690	12	21/5	W3x16q	W21/5W T20	10	700
269007	12	21/5	W3x16q	Amber T20	10	700

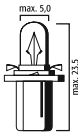

With plastic base



Type	V	W		i		
419101	12	1,2	B8,5d	Schwarz · black	10	50
449101	12	1,2	BX8,5d	Hellblau · light blue	10	100
459101	12	1,5	BX8,5d	Gelb · yellow	10	100
439101	12	2	B8,5d	Grün · green	10	100
479101	12	2	BX8,5d	Weißgrün · white green	10	100
419201	24	1,2	B8,5d	Grau · grey	10	100
419301	24	1,2	BX8,5d	Braun · brown	10	100

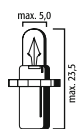



Type	V	W		i		
419102	12	1,2	B8,3d	Schwarz · black	10	100
439102	12	2	B8,3d	Weiß · white	10	100
419202	24	1,2	B8,3d	Grau · grey	10	100

With plastic base

Type	V	W		i		
419103	12	1,2	BX8,4d	Schwarz · black	10	100
449103	12	1,1	BX8,4d	Orange	10	100
479103	12	1,3	BX8,4d	Olivgrün · olive green	10	100
459103	12	1,5	BX8,4d	Beige	10	100
439103	12	2	BX8,4d	Grün · green	10	100



Type	V	W		i		
188328	24	1,2	EBS N10	Beige	10	100
183385	12	1,8	EBS R11	Grün · green	10	100
181471	24	1,2	EBS R6	Braun · brown	10	100
181791	24	1,2	EBS R4	Gelb · yellow	10	100
183527	24	1,2	EBS R10	Matt · frosted Weiß · white	10	100

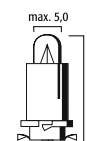
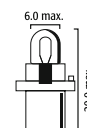

With plastic base

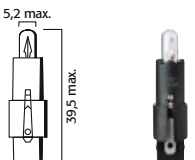
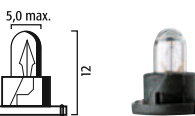
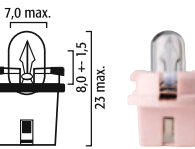
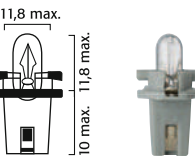
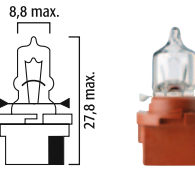
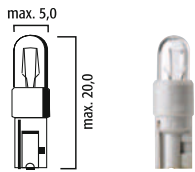
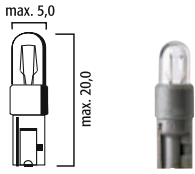



Type	V	W		i		
6924	12	0,5	W2x4,6d	PVC Grau · grey	10	100
6925	12	1,2	W2x4,6d	PVC Weiß · white	10	100
6441	24	1	W2x4,6d	PVC Weiß · white	10	100

Type	V	W		i		
409080	12	3	B10d	Halogen	10	100
429180	12	5	B10d	Halogen	10	100

Type	V	W		i		
419104	12	1,2	B8,7d	Grau · grey	10	100
439104	14	1 CP	B11d-T7	Rosa · pink	10	100
449105	14	1,4	HRQ	Schwarz · black	10	100
181649	12	1,2	SG8-5,5d	Schwarz · black	10	100

Festoons

Type	V	W		i		
6127	6	1	SV5,5 6x24 mm		10	100
6137	6	1,2	SV5,5 6x31 mm		10	100
6158	12	3	SV5,5 6,3x36 mm		10	100
6159	24	3	SV5,5 6,3x36 mm		10	100
5148	12	3	SV5,5 6,2x28 mm		10	100
5149	24	3	SV5,5 6,2x28 mm		10	100
5157	6	3	SV7 8x28 mm		10	100
5158	12	3	SV7 8x28 mm		10	100
5159	24	3	SV7 8x28 mm		10	100

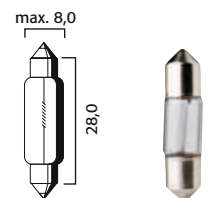
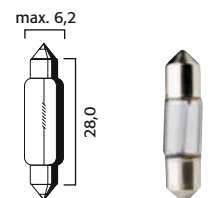
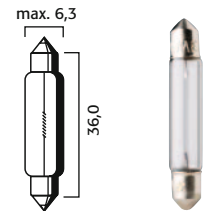
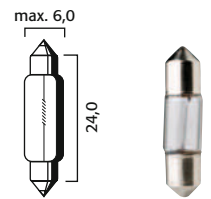

Festoons

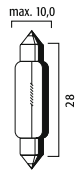

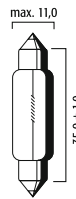

Type	V	W		i		
5168	12	10	SV8,5 10x28 mm		10	100
516835	12	10	SV8,5 10x28 mm	Dunkelblau · dark blue	10	100



Type	V	W		i		
4032	6	5	SV8,5 11x35 mm	C5W	10	100
4033	12	5	SV8,5 11x35 mm	C5W	10	200
94033	12	5	SV8,5 11x35 mm	C5W Blister	1	75
4002	24	5	SV8,5 11x35 mm	C5W	10	200

Festoons

Type	V	W		i		
403310	12	10	SV8,5 11x35mm		10	100
400210	24	10	SV8,5 11x35mm		10	100
403333	12	5	SV8,5 11x35mm	Blau · blue	10	100
403334	12	5	SV8,5 11x35mm	Grün · green	10	100
400233	24	5	SV8,5 11x35mm	Blau · blue	10	100

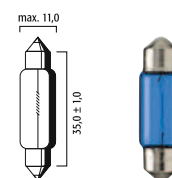
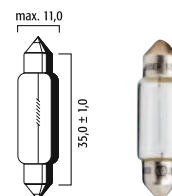

Festoons

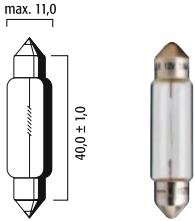

Type	V	W		i		
4230	12	5	SV8,5 11x40mm		10	200
4206	24	5	SV8,5 11x40mm		10	200

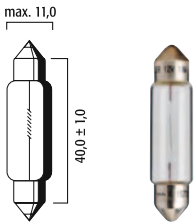

Type	V	W		i		
4203	6	10	SV8,5 11x40mm		10	200
4231	12	10	SV8,5 11x40mm	DIN 72601 K	10	200
94231	12		SV8,5 11x40mm	DIN 72601 K Blister	1	75
4210	24	10	SV8,5 11x40mm		10	200

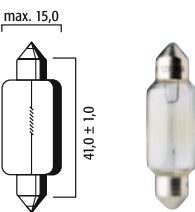

Type	V	W		i		
400115	6	15	SV8,5 15x41 mm		10	100
400415	12	15	SV8,5 15x41 mm		10	200
4215	24	15	SV8,5 15x41 mm		10	200

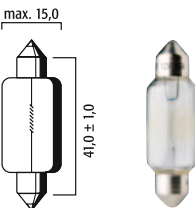



400118	6	18	SV8,5 15x41 mm		10	100
400418	12	18	SV8,5 15x41 mm		10	200
4218	24	18	SV8,5 15x41 mm		10	200
400421	12	21	SV8,5 15x41 mm	C21W	10	100

Festoons

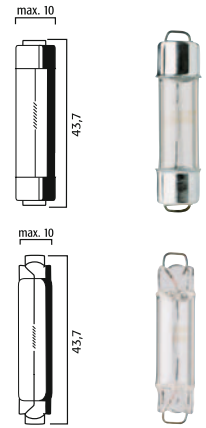
Type	V	W		i		
211-2	12,8	12 CP	Miniature Cap		10	200
561	12,8	12 CP	Rigid Loop		10	100





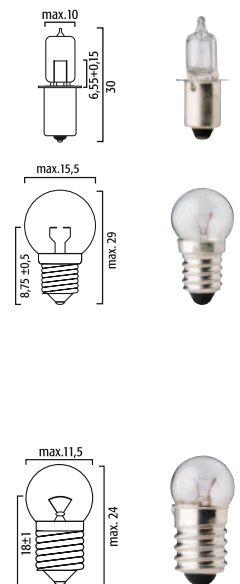

Bicycle lamps

Type	V	W		i		
6024	6	2,4	PX13,5s	HS3, Halogen	10	200
624	6	2,4	E10	C2,4W	10	100
660	6	6,0	E10		10	100
606	6	0,6	E10	C0,6W	10	100

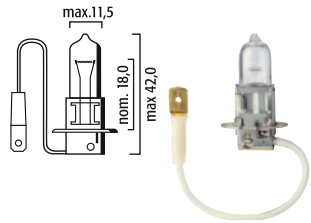

High Voltage



Type	V	W		i		
3348	48	45	PK22s	H3	10	100
3380	80	55	PK22s	H3	10	100

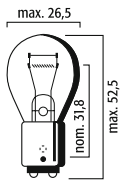

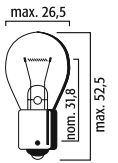

9629	48	25/10	BAY15d		10	200
------	----	-------	--------	--	----	-----



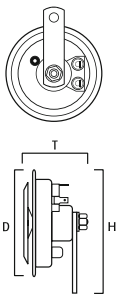

9671	48	25	BA15s		10	200
------	----	----	-------	--	----	-----



Type	V	i		
483359	48	91 mm disc horn, 340 Hz D = 90 mm +/- 1 T = 56 mm +/- 1 H = 115 mm	1	26

High Voltage

Type	V	A	i		
5038xx	58	2 - 30	Farbkodiert · color coded	50	500
7048xxx	58	30 - 200	Farbkodiert · color coded	10	100
6089xx	58	20 - 60	Farbkodiert · color coded	10	100
9048xxx	58	50 - 300		10	100
2848xx	80	1 - 40	Farbkodiert · color coded	10	500

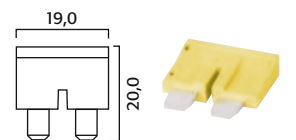
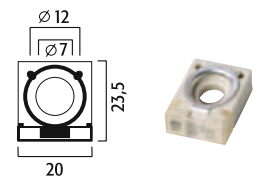
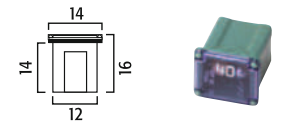
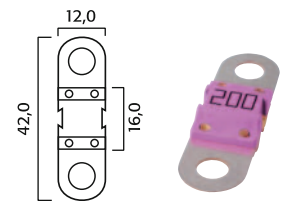
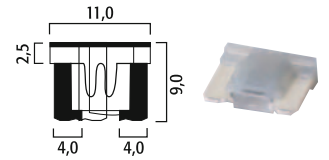

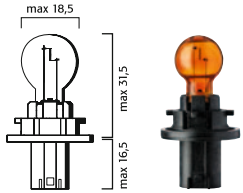



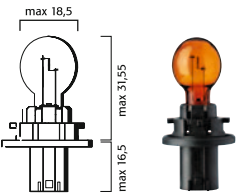
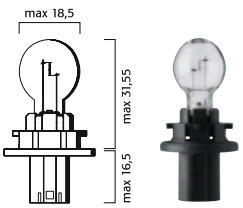
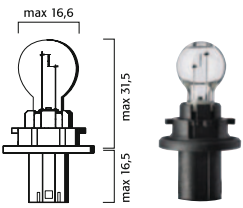

Type	V	W		i		
38965433	12	16	PU20d/2	HPC16WY Amber	1	10
77715934	12	16	PU20d/1	HPC16W	1	10
77715941	12	19	PU20d/3	HPC19W	1	10
77715958	12	24	PU20d/6	HPC24WY Amber	1	10

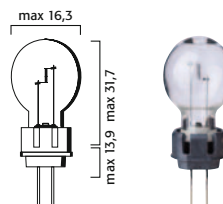
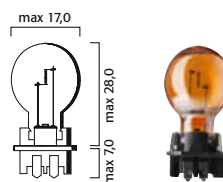
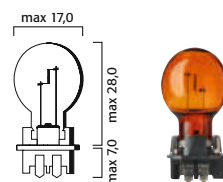
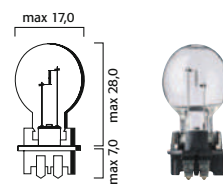
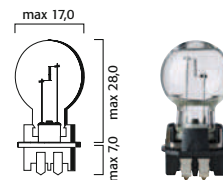

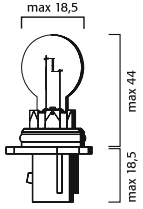



Type	V	W		i		
39623230	12	16	WP3,3x14,5/4	PW16W	1	10
39196133	12	24	WP3,3x14,5/3	PW24W	1	10
39202933	12	24	WP3,3x14,5/4	PWY24W Amber	1	10
39200533	12	24	WP3,3x14,5/4	PWY24W SV	1	10
39621860	13,5	24	Hiper LCP HTR HPSL2A		1	10



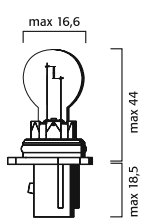
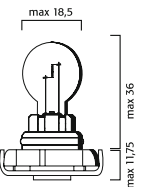
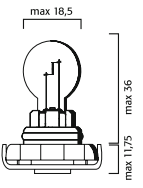
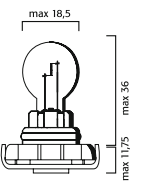

Type	V	W		i		
38874933	12	26	PG18.5d-3	PSX26W	1	10
52735233	12	19	PG20/2	PSY19W Amber	1	10
69653033	12	19	PG20/1	PS19W	1	10
69668433	12	24	PG20/4	PSY24W Amber	1	10
69672133	12	13	PG18.5-d1	P13W	1	10



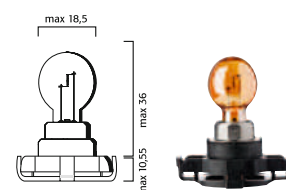
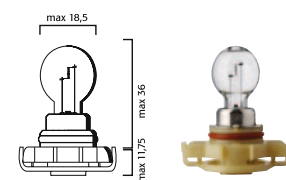
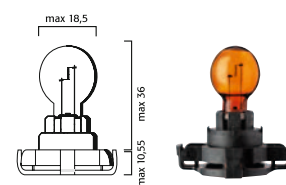
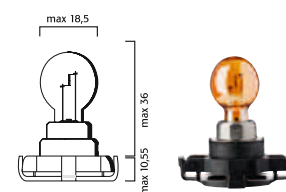
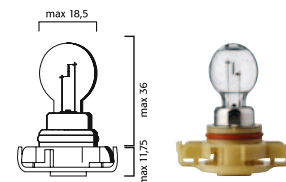

Type	V	W		i		
69676933	12	24	PG20/7	PSX24W	1	10
69678333	12	24	PGU20/4	PY24W SV	1	10
69690533	12	24	PGU20/4	PY24W Amber	1	10
70044233	12	24	PG20/3	PS24W FF	1	10
70379533	12	24	PG20/4	PSY24W SV+	1	10





Mega Lamps +50%

+50%

Type	V	W		i		
3021890	12	55	P14,5s	H1 +50%	10	100
2070890	12	55	PX26d	H7 +50%	10	100
6289043	12	60/55	P43t	H4 +50%	10	100

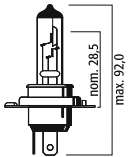
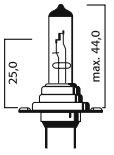
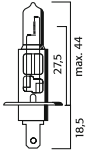



i



Megalamps +50% give up to 50% more light than the standart bulbs, but they are legal to use in public traffic with E1-sign.

+50% twinbox

Type	i		
3021680	Doppelbox · twinbox 2 x 3021890 12 V 55 W P14,5s H1 Mega +50%	1	10
2070680	Doppelbox · twinbox 2 x 2070890 12 V 55 W PX26d H7 Mega +50%	1	10
6255680	Doppelbox · twinbox 2 x 6289043 12 V 60/55 W P43t H4 Mega +50%	1	20

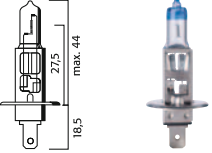
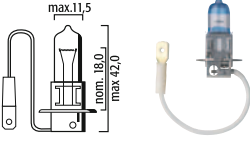
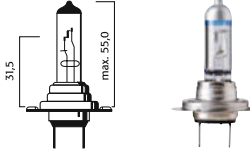
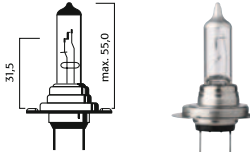
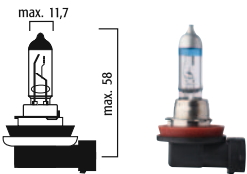
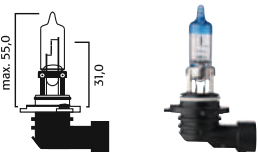
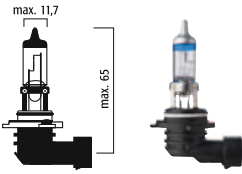
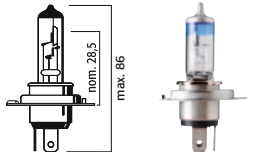
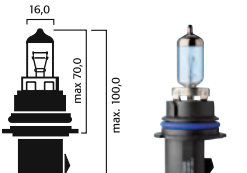

+90% / +100%

Type	V	W		i		
	12	55	P14,5s	H1 Ultra +90%	10	100
	12	55	PK22s	H3 Ultra +90%	10	100
	12	55	PX26d	H7 Ultra +90%	10	100
	12	55	PX26d	H7 Ultra + 100%	10	100
	12	55	PGJ19-2	H11 Ultra +90%	10	100
	12	60	P20d	HB3 Ultra +90%	10	100
	12	51	P22d	HB4 Ultra +90%	10	100
	12	60/55	P43t	H4 Ultra +90%	10	100
	12	65/45	P29t	HB1 Ultra + 100%	10	100



i

Safer driving with Ultra lamps: FLÖSSER Ultra lamps produce up to 90% more light and high luminosity. The partial blue coating on the glass creates a day white light. Tested and approved in public traffic according to ECE R37 with E1.

+90% twinbox

Type	i		
3021180	Doppelbox · twinbox 2 x 3021900 12 V 55 W P14,5s H1 Ultra +90%	1	10
2070180	Doppelbox · twinbox 2 x 2070900 12 V 55 W PX26d H7 Ultra +90%	1	10
6255180	Doppelbox · twinbox 2 x 6290043 12 V 60/55 W P43t H4 Ultra +90%	1	20



+30% 4200°K

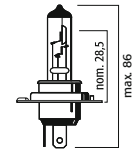
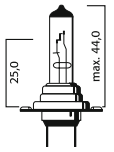
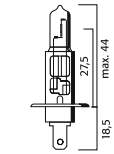

Type	V	W		i		
3021300	12	55	P14,5s	H1 Ultra White 4200°K +30%	10	100
2070300	12	55	PX26d	H7 Ultra White 4200°K +30%	10	100
6230043	12	60/55	P43t	H4 Ultra White 4200°K +30%	10	100



i

A light bulb's color temperature is given in degrees Kelvin. The higher the value, the whiter the light. FLOESSER Ultra White bulbs feature a color temperature of 4.200 °K – comparable to Xenon HID lamps – and create a brilliantly bright white light. At the same time they retain standard wattage and are street legal.

+30% 4200°K twinbox

Type	i		
3021600	Doppelbox · twinbox 2 x 3021300 12 V 55 W P14,5s H1 Ultra White 4200°K +30%	1	10
2070600	Doppelbox · twinbox 2 x 2070300 12 V 55 W PX26d H7 Ultra White 4200°K +30%	1	10
6235600	Doppelbox · twinbox 2 x 6230043 12 V 60/55 W P43t H4 Ultra White 4200°K +30%	1	20



Silverblue Rally

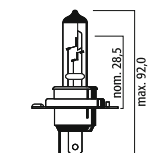
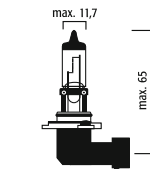
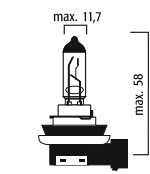
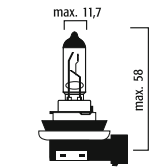
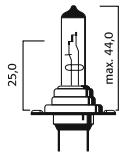
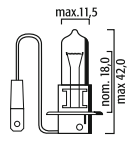
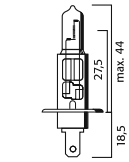

Type	V	W		i		
3021335	12	70	P14,5s	H1 Rally Silberblau silverblue	10	100
3320335	12	70	PK22s	H3 Rally Silberblau silverblue	10	100
2070335	12	70	PX26d	H7 Rally Silberblau silverblue	10	100
2080335	12	50	PGJ19-1	H8 Rally Silberblau silverblue	10	100
2110335	12	70	PGJ19-2	H11 Rally Silberblau silverblue	10	100
9006335	12	60	P22d	HB4 Rally Silberblau silverblue	10	100
7255335	12	100/90	P43t	H4 Rally Silberblau silverblue	10	100

i

The Silverblue FLOESSER lamps have a shining blue coating and silver caps. They produce a brilliant white light of 4.300°K like Xenon HID.



Silverblue Rally twinbox

Type	i		
3021670	Doppelbox · twinbox 2 x 3021335 12 V 70 W P14,5s H1 Rally Silberblau · silverblue	1	10
2070670	Doppelbox · twinbox 2 x 2070335 12 V 70 W PX26d H7 Rally Silberblau · silverblue	1	10
7255670	Doppelbox · twinbox 2 x 7255335 12 V 100/90 W P43t H4 Rally Silberblau · silverblue	1	20





LED headlights



Type	V		i		
	12	P43t	H4 LED 6500° K Set containing 2 pieces	1	10
	12	PX26d	H7 LED 6500°K Set containing 2 pieces	1	10
	12	PGJ19-X	H8 / H9 / H11 / H16 LED 6500° K Set containing 2 pieces	1	10



i

LED headlights are not ECE approved and may not be used on public roads. Therefore these items are not available for sale in all countries.



Type	i		
91414003	Canceller / CANBus Adapter for H7 LED Prevents warnings and non-recognition	1	10
91488003	Canceller / CANBus Adapter for H8, H9, H11 and H16 LED Prevents warnings and non-recognition	1	10

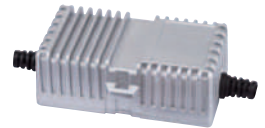

LED retrofit

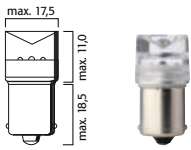
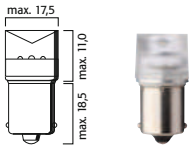

R5W

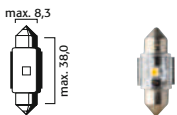
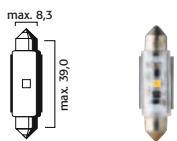
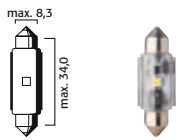
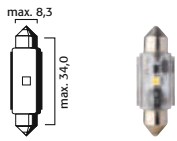

Type	V		i		
914020	12-24	BA15s 18x36 mm	R5W LED super white frosted cover	1	90
914028	12-24	BA15s 18x36 mm	R5W LED red clear cover	1	90

Festoons



Type	V		i		
914030	12-24	SV8,5 13,5x38 mm	C5W LED super white	1	180
914031	12-24	SV8,5 13,5x38 mm	C5W LED white	1	180
914231	12-24	SV8,5 13,5x44 mm	K type LED white	1	180
915168	12-24	SV8,5 13,5x31 mm	5168 type LED white	1	180



W5W

Type	V		i		
914290	12-24	W2,1x9,5d	W5W LED super white frosted cover Doppelbox · twinbox	1	180
914293	12-24	W2,1x9,5d	W5W LED blue clear cover Doppelbox · twinbox	1	180

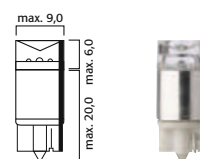
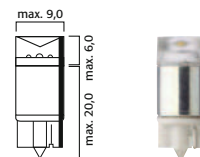

P21W

Type	V		i		
916670	12	BA15s 26,5x50mm	P21W LED super white frosted cover	1	90
916677	12	BA15s 26,5x50mm	P21W LED Amber clear cover	1	90
916678	12	BA15s 26,5x50mm	P21W LED Red clear cover	1	90
916652	24	BA15s 26,5x50mm	P21W LED super white frosted cover	1	90
916658	24	BA15s 26,5x50mm	P21W LED Red clear cover	1	90

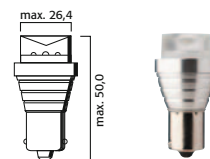

P21/5W

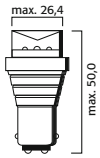

Type	V		i		
915220	12	BAY15d 26,5x50 mm	P21/5W LED super white frosted cover	1	90
915227	12	BAY15d 26,5x50 mm	P21/5W LED Amber clear cover	1	90
915228	12	BAY15d 26,5x50 mm	P21/5W LED Red clear cover	1	90
915239	24	BAY15d 26,5x50 mm	P21/5W LED super white frosted cover	1	90
915238	24	BAY15d 26,5x50 mm	P21/5W LED Red clear cover	1	90



W21W

Type	V		i		
912190	12	W3x16d	W21W LED super white frosted cover	1	90
912197	12	WX3x16d 26,5x50mm	WY21W LED Amber clear cover	1	90
912198	12	W3x16d	W21W LED Red clear cover	1	90

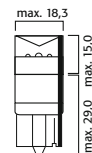

W21/5W

Type	V		i		
912690	12	W3x16q 26,5x50mm	W21/5W LED super white frosted cover	1	90
912697	12	W3x16q 26,5x50mm	W21/5W LED Amber clear cover	1	90
912698	12	W3x16q 26,5x50mm	W21/5W LED Red clear cover	1	90

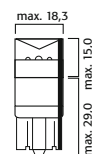



Type	i
9625543 9725543	H4 H4 Rally
96290043	H4 Ultra +90%
96230043	H4 Ultra white +30%



93021	H1
93021900	H1 Ultra +90%
93021300	H1 Ultra white +30%



Type	i
93320	H3
93320900	H3 Ultra +90%



92070	H7
92070900	H7 Ultra +90%
92070300	H7 Ultra white +30%









Type	İ
92080	H8
92090	H9
92110	H11
92110900	H11 Ultra +90%



Type	İ
99005	HB3
99005900	HB3 Ultra +90%
99006	HB4
99006900	HB4 Ultra +90%



Type	i
	P21W
	P21/5W
	PY21W
	P27W
	P27/7W

Type	i
	T20 W21W
	T20 W21/5W
	R5W
	R10W
	RY10W



Type	İ
9921	W16W
94088	T4W
94291	W5W
94191	W1,2W
94033	C5W



Type	İ
94231	Form K
99004	HB1
99007	HB5







Fuses



Germany







A word on fuses

Sometimes it's the small things that are important. Car fuses, for example. They protect your car and its cable harnesses against damage caused by short circuits or excess currents; thus against cable or engine fire. Our fuses are of first class quality: a body made of self-extinguishing plastic and zinc contacts. So only a few cents to protect your precious car!

Fuses

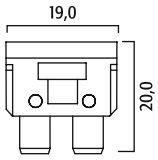
Blade fuses



Type	V	A	i		
214801	32	1	black	50	4000
214802	32	2	grey	50	4000
214803	32	3	violet	50	4000
214804	32	4	pink	50	4000
214805	32	5	light brown	50	4000
214875	32	7,5	brown	50	4000
214810	32	10	red	50	4000
214815	32	15	light blue	50	4000
214820	32	20	yellow	50	4000
214825	32	25	white	50	4000
214830	32	30	light green	50	4000
214840	32	40	orange	50	4000
214800	Blisterpack containing 1 x 5 A, 7,5 A, 25 A & 30 A 2 x 10 A, 15 A & 20 A			1	100

80 V blade fuses

Type	V	A	i		
284801	80	1	black	10	500
284802	80	2	grey	10	500
284803	80	3	violet	10	500
284804	80	4	pink	10	500
284805	80	5	light brown	10	500
284875	80	7,5	brown	10	500
284810	80	10	red	10	500
284815	80	15	blue	10	500
284820	80	20	yellow	10	500
284825	80	25	natural	10	500
284830	80	30	green	10	500
284840	80	40	orange	10	500

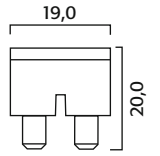

Big blade fuses

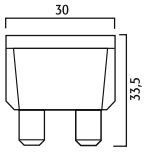

Type	V	A	i		
314820	32	20	yellow	5	400
314825	32	25	grey	5	400
314830	32	30	green	5	400
314840	32	40	orange	5	400
314850	32	50	red	5	400
314860	32	60	light blue	5	400
314870	32	70	brown	5	400
314880	32	80	white	5	400
3148100	32	100	violet	5	400



Small blade fuses

Type	V	A	i		
514801	32	1	black	50	7500
514802	32	2	grey	50	7500
514803	32	3	violet	50	7500
514804	32	4	pink	50	7500
514805	32	5	light brown	50	7500
514875	32	7,5	brown	50	7500
514810	32	10	red	50	7500
514815	32	15	light blue	50	7500
514820	32	20	yellow	50	7500
514825	32	25	white	50	7500
514830	32	30	green	50	7500
514800	Blisterpack containing · 1 x 5 A, 7,5 A, 25 A & 30 A 2 x 10 A, 15 A & 20 A			1	100

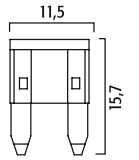

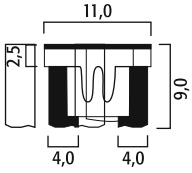

Fuses

Small low profile blade fuses



Type	V	A	i		
503802	58	2	grey	50	500
503803	58	3	violet	50	500
503804	58	4	pink	50	500
503805	58	5	light brown	50	500
503875	58	7,5	brown	50	500
503810	58	10	red	50	500
503815	58	15	light blue	50	500
503820	58	20	yellow	50	500
503825	58	25	white	50	500
503830	58	30	green	50	500
513800	Blisterpack containing 1 x 5 A, 7,5 A, 25 A, 30 A and 2 x 10 A, 15 A, 20 A.			1	100

Small micro II blade fuses

Type	V	A	i		
502805	32	5	light brown	50	500
502875	32	7,5	brown	50	500
502810	32	10	red	50	500
502815	32	15	light blue	50	500
502820	32	20	yellow	50	500
502825	32	25	white	50	500
502830	32	30	green	50	500

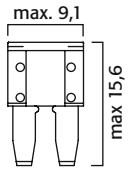

Small micro III blade fuses

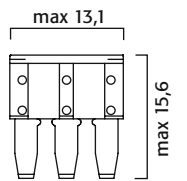

Type	V	A	i		
501805	32	5	light brown	50	500
501875	32	7,5	brown	50	500
501810	32	10	red	50	500
501815	32	15	light blue	50	500

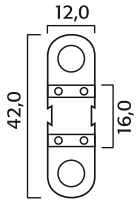

Fuses

Small bolt-on fuses



Type	V	A	i		
7048030	58	30	orange	10	100
7048040	58	40	green	10	100
7048050	58	50	red	10	100
7048060	58	60	yellow	10	100
7048070	58	70	brown	10	100
7048080	58	80	white	10	100
7048100	58	100	blue	10	100
7048125	58	125	pink	10	100
7048150	58	150	grey	10	100
7048175	58	175	light brown	10	100
7048200	58	200	violet	10	100

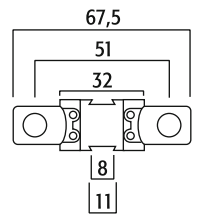

Big bolt-on fuses

Type	V	A	i		
8048080	32	80	black	10	50
8048100	32	100	yellow	10	50
8048125	32	125	green	10	50
8048150	32	150	orange	10	50
8048175	32	175	white	10	50
8048200	32	200	blue	10	50
8048225	32	225	light brown	10	50
8048250	32	250	pink	10	50
8048300	32	300	grey	10	50
8048350	32	350	dark green	10	50
8048400	32	400	violet	10	50
8048450	32	450	yellow ochre	10	50
8048500	32	500	brown	10	50



Fuses

Glass fuses

Type	V	A	i			
3201	32	1	6,3x32mm	SAE J554	50	500
3203	32	3	6,3x32mm	SAE J554	50	500
3204	32	4	6,3x32mm	SAE J554	50	500
3205	32	5	6,3x32mm	SAE J554	50	500
3210	32	10	6,3x32mm	SAE J554	50	500
3215	32	15	6,3x32mm	SAE J554	50	500
3220	32	20	6,3x32mm	SAE J554	50	500
3225	32	25	6,3x32mm	SAE J554	50	500
3230	32	30	6,3x32mm	SAE J554	50	500
3240	32	40	6,3x32mm	SAE J554	50	500

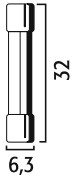

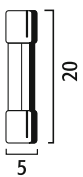

Glass fuses

Type	V	A	i			
1014005	32	0,5	5x20mm, quick		50	500
1014010	32	1	5x20mm, quick		50	500
1014012	32	1,25	5x20mm, quick		50	500
1014016	32	1,6	5x20mm, quick		50	500
1014020	32	2	5x20mm, quick		50	500
1014025	32	2,5	5x20mm, quick		50	500
1014031	32	3,15	5x20mm, quick		50	500
1014040	32	4	5x20mm, quick		50	500
1014050	32	5	5x20mm, quick		50	500
1014063	32	6,3	5x20mm, quick		50	500
1014100	32	10	5x20mm, quick		50	500



Thermoplastic fuses

Formerly ceramic fuse

Type	V	A	i		
124805	32	5	yellow	100	3600
124808	32	8	white	100	3600
124816	32	16	red	100	3600
124825	32	25	blue	100	3600
124840	32	40 (25)	blue	100	3600

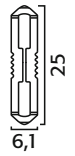

Type J

Type	V	A	i		
609020	32	20	blue	10	100
609025	32	25	light grey	10	100
609030	32	30	pink	10	100
609040	32	40	green	10	100
609050	32	50	red	10	100
609060	32	60	yellow	10	100

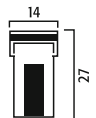

Type J small

Type	V	A	i		
608920	58	20	blue	10	100
608925	58	25	light grey	10	100
608930	58	30	pink	10	100
608940	58	40	green	10	100
608950	58	50	red	10	100
608960	58	60	yellow	10	100

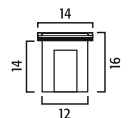

Fuses



Type J micro

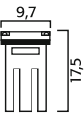

Type	V	A	i		
608815	32	15	grey	10	100
608820	32	20	blue	10	100
608825	32	25	light grey	10	100
608830	32	30	pink	10	100
608840	32	40	green	10	100

Type JMS



Type	V	A	i		
608715	12	15	grey	10	100
608720	12	20	blue	10	100
608725	12	25	white	10	100
608730	12	30	pink	10	100
608740	12	40	green	10	100
608750	12	50	red	10	100
608760	12	60	yellow	10	100

Type B

Type	V	A	i		
604830	32	30	pink	10	50
604840	32	40	green	10	50
604850	32	50	red	10	50
604860	32	60	yellow	10	50
604870	32	70	brown	10	50
604880	32	80	black	10	50
604900	32	100	blue	10	50
604920	32	120	white	10	50
604940	32	140	dark red	10	50

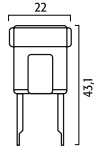

Type AS

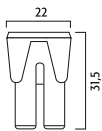

Type	V	A	i		
605020	32	20	blue	10	50
605030	32	30	pink	10	50
605040	32	40	green	10	50
605050	32	50	red	10	50
605060	32	60	yellow	10	50



Fuses

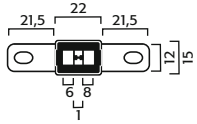

Type C



Type	V	A	i		
607030	32	30	pink	10	50
607040	32	40	green	10	50
607050	32	50	red	10	50
607060	32	60	yellow	10	50
607080	32	80	black	10	50
6070100	32	100	blue	10	50
6070120	32	120	white	10	50

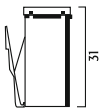

Type D

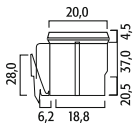

Type	V	A	i		
608525	32	25	brown	10	50
608530	32	30	green	10	50

Type E



Type	V	A	i		
609545	32	45	red	10	50
609565	32	65	black	10	50
609575	32	75	grey	10	50

Fuse strips

Type	V	A	i		
38030	32	30		50	500
38040	32	40		50	500
38050	32	50		50	500
38060	32	60		50	500
38080	32	80		50	500
38100	32	100		50	500

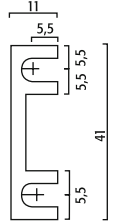

Type HSB

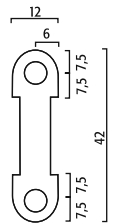

Type	V	A	i		
39030	32	30		50	500
39040	32	40		50	500
39050	32	50		50	500
39060	32	60		50	500
39080	32	80		50	500
39100	32	100		50	500
39110	32	110		50	500
39125	32	125		50	500
39150	32	150		50	500
39175	32	175		50	500



Fuses

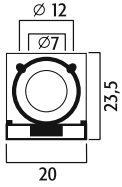

Compact fuses

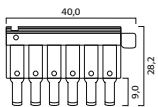

Type	V	A	i		
9048050	58	50		10	100
9048075	58	75		10	100
9048100	58	100		10	100
9048125	58	125		10	100
9048150	58	150		10	100
9048175	58	175		10	100
9048200	58	200		10	100
9048250	58	250		10	100
9048300	58	300		10	100

MB fuses



Type	V	A	i		
315805	32	5	orange 6 Pins	3	3
315875	32	7,5	brown 6 Pins	3	3
315820	32	5 & 7,5	Set of 3x 315805 and 3x 315875	6	6



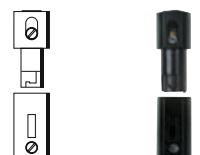
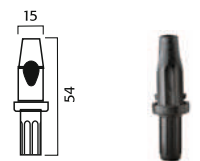
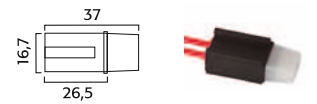
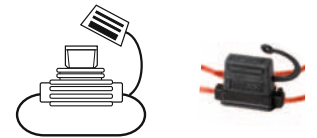
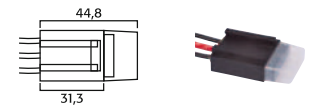
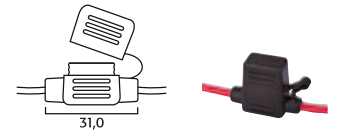

Inline fuse holders

Type	i		
6302	inline fuseholder for 5028xx	10	200
6303	fuseholder for 5018xx porte	10	200
6306	inline fuse holder for 2148xx waterproof with cable	10	200
6307	inline fuse holder for 5148xx waterproof with cable	10	200
6308	fuseholder for 5038xx	10	200
6309	fuseholder for 5148xx with cable	10	200
121400	inline fuseholder for 1014xxx	1	100
124800	inline fuseholder for ceramic fuses with fuse 8 A	10	100

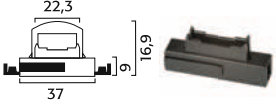
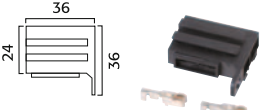

Fuse holders

For 2148xx

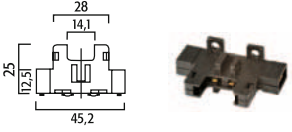
Type				
	1135	fuseholder with crimp contacts and cap	10	100
	2211	fuseholder with crimp contacts, stackable with relays sockets 2222	10	10
	1110	fuseholder with blade terminals, stackable	10	10
	178200	fuseholder with blade terminals, stackable	10	10
	1020	fuseholder with blade terminals, stackable	10	10

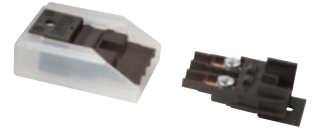
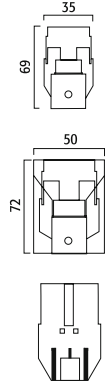

For 3148xx

Type	i		
324800	fuseholder for 3148xx with screw connection porte	1	100
324822	cover for 314800	1	100
324844	fuseholder 324800 and cover 324822	1	100





Fuse holders

Fuseholders

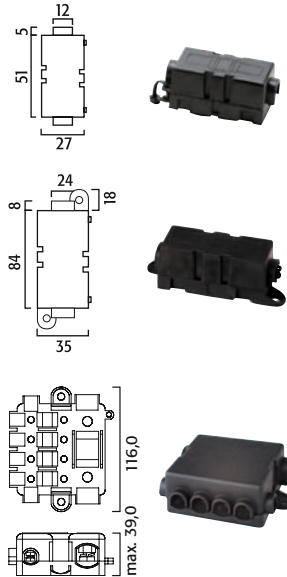
Type	A		
724800	fuseholder for 7048xxx	1	1
824800	fuseholder for 8048xxx	1	1
372400	Fuseholder for 4x 7048xxx with 200 A max. and 1x 8048xxx fuse	1	1



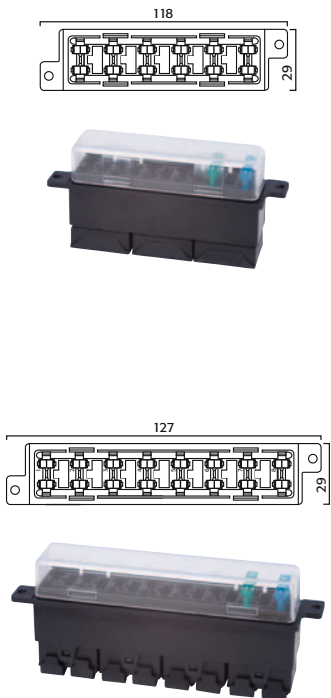

Fusebox

Type	i		
234600	Fusebox Contents 1 x Fusebox with cover · 3 x connector	1	300
234800	Fusebox Contents 1 x Fusebox with cover · 4 x connector 16 x secondary lock	1	250



Circuit+

Type	A		
630701	Fuseholder with secured additional circuit for mini fuses with 15 A max	10	10
630501	Fuseholder with secured additional circuit for micro II fuses with 10 A max	10	10
630801	Fuseholder with secured additional circuit for mini LP fuses with 10 A max	10	10
630601	Fuseholder with secured additional circuit for regular fuses with 15 A max	10	10

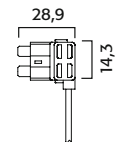
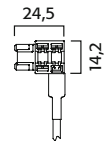
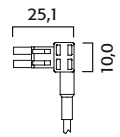
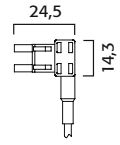





Relays and flashers







FLÖSSER Relays

Relays are used to avoid voltage drops and resulting performance losses of attached voltage consumers. A drop of only 10% of the nominal voltage used in your car may already lead to performance losses of light output greater than 33%! We offer two types of mini relays: normally open relays and changeover relays.

The normally open relay is used to close the electrical contact and to switch your consumer on; typical appliances are head lights, additional driving or fog lights, horns, alarms etc. The changeover relay switches from one consumer to another, e.g. switching from horns to fanfares or when adjusting the ventilator speed, etc.

Essential quality features of relays are the material used, the perfect winding of the coil and the exact positioning of contact points. All these result in good performance over a long lifetime. The designation of pins follows an international rule, e.g. the pin 30 is used only for "current in", while 87 designates the pin "current out".



The new generation of FLÖSSER relays have color coded bottom plates and carry the "E" and "CE" sign as proof of electromagnetic compatibility.







Mini relays

Normally open relays with 4 terminals

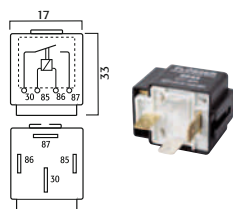
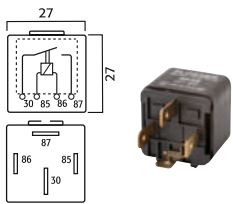
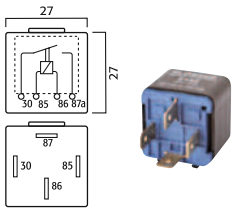
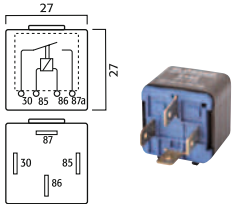
Type	V	A	i		
All with bracket					
2142	12	30		10	350
2143	12	30	with resistance	10	350
2144	12	40		10	350
4142	24	20		10	350
4143	24	20	with resistance	10	350
2242	12	30		10	350
2245	12	30	with resistance	10	350
4242	24	20		10	350
2243	12	30	with fuse	10	350
4243	24	20	with fuse	10	350



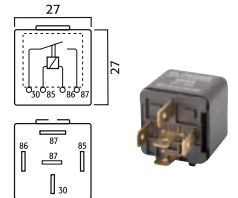

Normally open relays with 5 terminals

Type	V	A	i		
All with bracket					
2252	12	30		10	350
2254	12	40		10	350
4252	24	20		10	350
4254	24	30		10	350



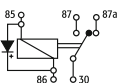
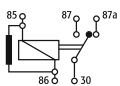
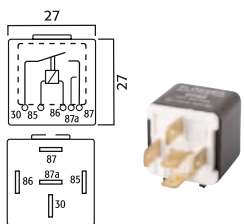
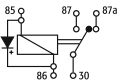
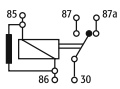
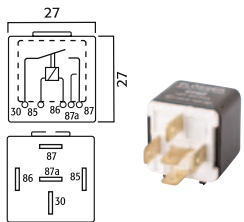
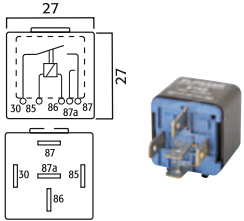

Changeover relay

Type	V	A	i		
All with bracket					
2162	12	20/30		10	350
4162	24	10/20		10	350
2262	12	20/30		10	350
2268	12	30/40		10	350
2263	12	20/30	with resistance	10	350
2265	12	20/30	with diode	10	350
4262	24	10/20		10	350
4268	24	20/30		10	350
4263	24	10/20	with resistance	10	350
4265	24	10/20	with diode	10	350



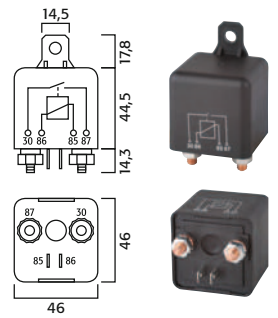
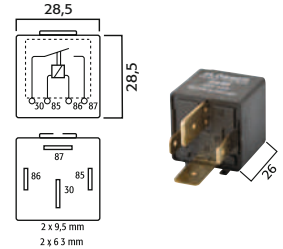

High power relay

Type	V	A	i		
All with bracket					
2246	12	40	Audi/VW type	10	350
2248	12	50		10	350
2270	12	70		10	350
2271	12	70	with diode	10	300
9242	12	200	Heavy duty high power big housing	10	300
2274	24	40		10	350
2275	24	70	big housing	10	100
2276	24	70	Small housing	10	300





Mini relays

High power changeover

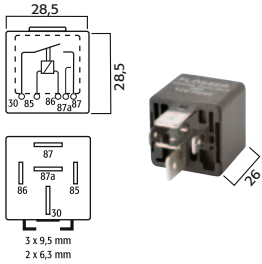
Type	V	A	i		
All with bracket					
2264	12	70/60		10	350
4264	24	40/30		10	350



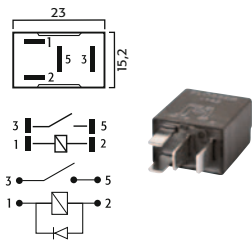

Normally open

Type	V	A	i		
1142	12	25		10	350
1143	12	25	with diode	10	350
1443	24	10	with diode	10	350



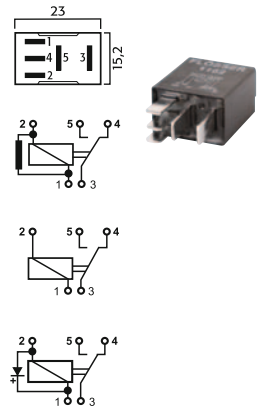

Changeover

Type	V	A	i		
1162	12	15/25		10	350
1163	12	15/25	with diode	10	350
1164	12	15/25	with resistance	10	350
1462	24	5/10		10	350
1463	24	5/10	with diode	10	350
1464	24	5/10	with resistance	10	350
1465	24	10/15	with resistance	10	350



Battery relays

Type	V	A	i		
9458	12	150	Smart battery relay	1	30

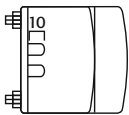
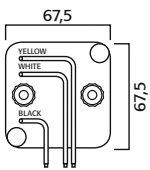
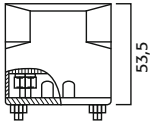
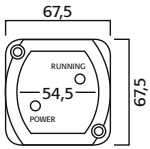

Voltage Sensitive Battery Relay for simultaneous use of two 12 volt batteries.

The Voltage Sensitive Relay allows two batteries to be charged at the same time. When the engine is running the two battery banks (start and house) can be charged simultaneously. When the voltage drops below 12.65 volts (engine is not running) the relay drops out, separating the batteries. This system prevents the starter battery from draining and protects sensitive electronic equipment powered by the house battery against harmful engine start-up spikes. Additionally, the relay prohibits both batteries from draining each other after a prolonged downtime.

The optional Boost-Switch allows both batteries to be interconnected when the individual charging level is too low to start the vehicle.

Battery relays

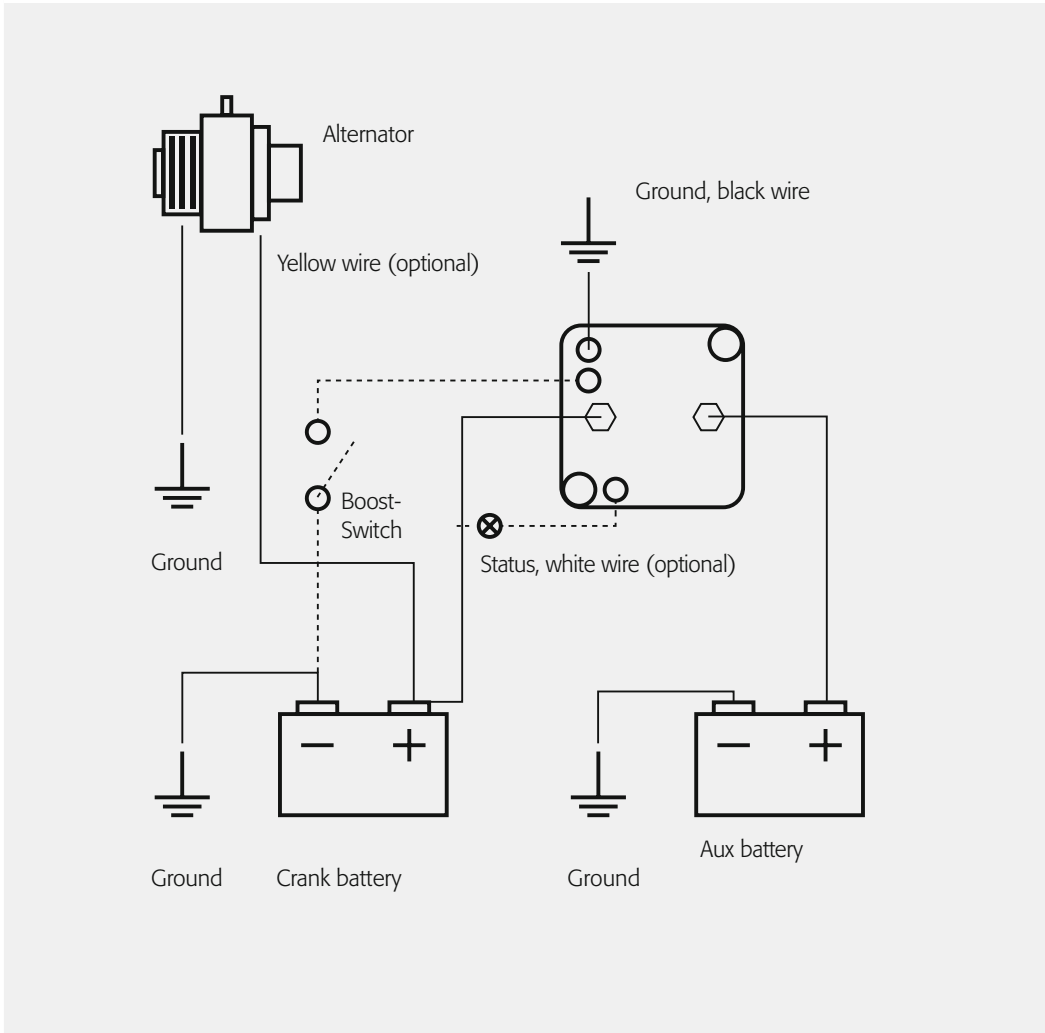

Flasher units

For motorcycles and cars

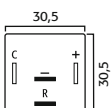
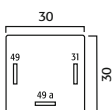
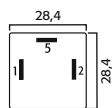
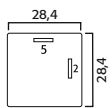
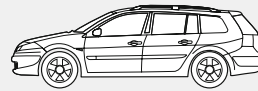
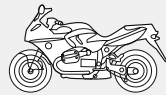

Type	V	i		
1621002	12	2 Terminals max. 300 W	10	100
1621003	12	3 Terminals max. 300 W	10	100
1622411	12	ohne Lasche no bracket 3 Terminals 2/4x21 W	10	100
1622421	12	with bracket 3 Terminals 2/4x21 W	10	100
1622425	12	4 Terminals 2/4x21 W SAE Standard	10	100

For trucks

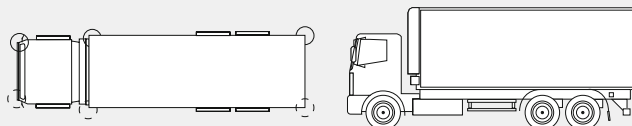

Type	V	i			
1642421	24	3 Terminals 2/4x21 W	10	100	
1632421	24	3 Terminals max. 170 W	10	100	
1641002	24	2 Terminals max. 150 W	10	100	
1641003	24	3 Terminals max. 150 W	10	100	
1628821	12 & 24	6 Terminals	1	5	
1634852	12 & 24	Max. 170 W no control of flashing bulbs sans	11 Terminals	1	5

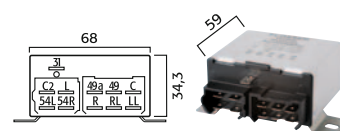
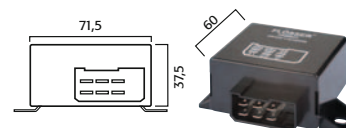
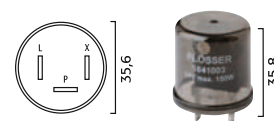
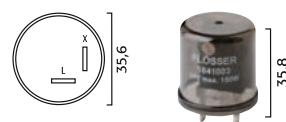
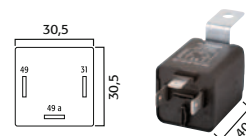







Signal horns



Disc and fanfare horns

Disc horns

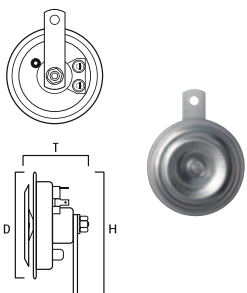
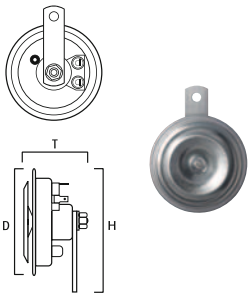
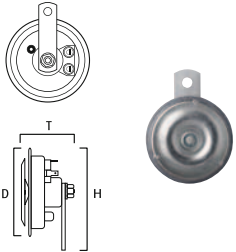
Type	V	i		
123357	12	70 mm disc horn, 340 Hz	1	48
124307	12	70 mm disc horn, 430 Hz	1	48
Dimension		D = 71,5 mm T = 41 mm H = 95 mm		
63359	6	91 mm disc horn, 340 Hz	1	30
123359	12	91 mm disc horn, 340 Hz	1	30
124309	12	91 mm disc horn, 430 Hz	1	30
Dimension		D = 90 mm +/-1 T = 57 mm +/-1 H = 115 mm		
127659	12	set of one 91 mm high and low frequency horn	1	20
243359	24	91 mm disc horn, 340 Hz	1	30
244309	24	91 mm disc horn, 430 Hz	1	30





Disc horns

Type	V	i		
247659	24	set of one 91 mm high and low frequency horn	1	20
483359	48	91 mm disc horn, 340 Hz	1	26



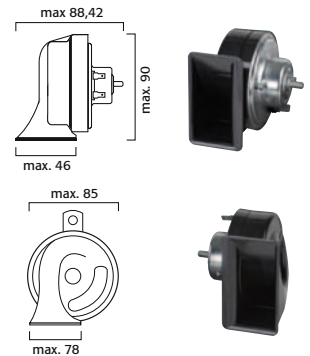

Fanfare horns

Type	V	i		
129206	12	High 500 Hz Low 410 Hz set of one high and low frequency fanfare horn	1	30
249206	24	High 500 Hz Low 410 Hz set of one high and low frequency fanfare horn	1	30

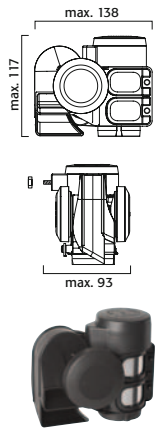

Ultra Air horns



Type	V	i		
11690120	12	HIGH 660 Hz \pm 5 % LOW 520 Hz \pm 5 % \geq 112 dB at 2 m two-tone air compressor horn	1	18
11690124	24	HIGH 660 Hz \pm 5 % LOW 520 Hz \pm 5 % \geq 112 dB at 2 m two-tone air compressor horn	1	18

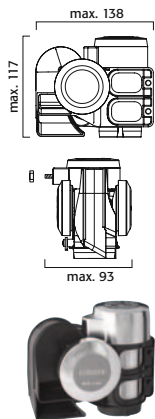

11690122	12	HIGH 660 Hz \pm 5 % LOW 520 Hz \pm 5 % \geq 112 dB at 2 m two-tone air compressor horn chrome finish	1	18
----------	----	---	---	----

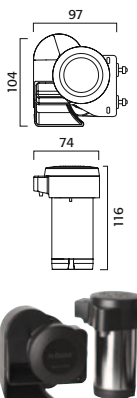



11690320	12	HIGH 660 Hz \pm 5 % LOW 520 \geq 112 dB at 2 m Hz \pm 5 % two-tone air horn with seperate compressor	1	18
----------	----	---	---	----

Disc and fanfare horns



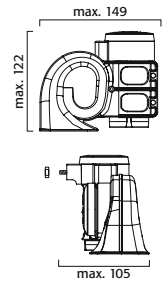

Ultra Air horns

Type	V	i		
11690220	12	300 Hz \pm 5 % \geq 112 dB at 2 m Air horn with low tone	1	18
11690240	24	300 Hz \pm 5 % \geq 112 dB at 2 m Air horn with low tone	1	18



Back-up alarm

Type	V	i		
128097	12-80	97dB Single unit containing relay and horn. Operating from 12-80 V, it is usable in regular cars, trucks, or e.g. fork lifts.	1	50

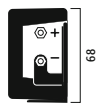
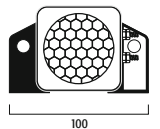





Accessories



Accessories

Cigarette lighters

Type	V	i		
181403	12	without light · with big button	1	100
181404	12	with light	1	100
181411	24	with light	1	100
181407	12	with light little knob	1	100



Power adapters

Type	V	i		
181399	12&24	power adapter with cover	1	100
181400	12	power adapter with light and cover	1	100
181412	24	power adapter with light and cover	1	100

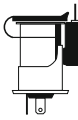

USB charger

Type	V	i		
181740	12&24	DC 5.0 V 4800 mA 2x USB-A 1x USB-C	1	100





Universal plug

Type	V	i		
181420	12&24	with 8 A fuse, suitable for all cigarette lighters and power adapters in this catalogue	1	100



Voltage tester

Type	i		
183044	for tensions 6 - 24 V	5	100
5149	replacement bulb		

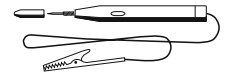

Bulb tester

Type	i		
183000	for bulbs with 6 - 24 V	1	1
16560	fuse tester and puller for plug-in fuses	1	1
16552	fuse puller for plug-in fuses	1	1



Bulb sockets

Type	i		
	holder for H4 with 2,5 mm ² cable	10	100
	holder for H4 with cable	10	300
	ceramic holder for H4 with cable	10	300
	holder for H1 with cable	10	300
	holder for H1 with cable	10	400
	holder for H1	10	300
	holder for H7 with cable	10	300
	holder for H8, H9 and H11 with cable	10	300



Bulb sockets

Type	i		
9445	holder for HB3, H10, H12 and HIR1 with cable	10	200
9449	holder for H13 with cable	10	200
9444	holder for 9004/9007 with cable	1	100
9446	holder for HB4 and HIR2 with cable	10	200
9440	holder for 880/893/890 with cable	10	300
9441	holder for 881/886/894/896 with cable	10	300

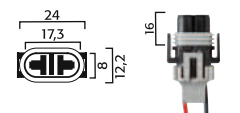
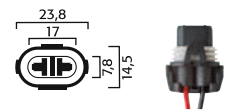
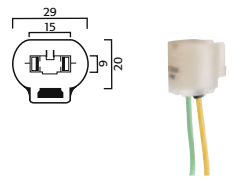
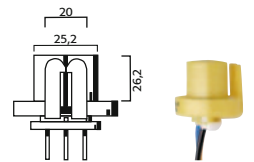
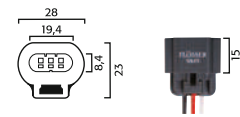
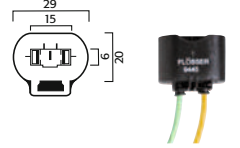

Bulb sockets

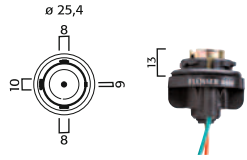

Type			
6444	holder for bulbs with BA15s socket with cable	10	200

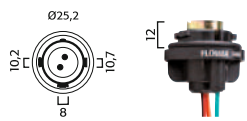

5444	holder for bulbs with BAY15d socket with cable	10	200
------	---	----	-----

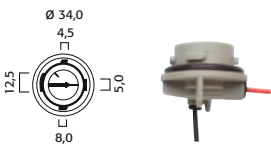

6445	holder for bulbs with BAU15s socket with cable	10	200
------	---	----	-----

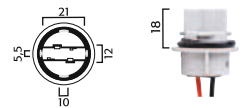

2444	holder for bulbs with socket W3x16d with cable	10	200
------	---	----	-----

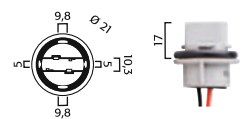

2644	holder for bulbs with socket W3x16q with cable	10	200
------	---	----	-----



Bulb sockets

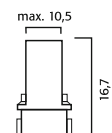
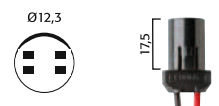
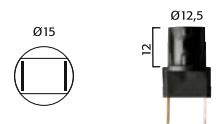
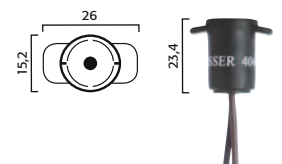
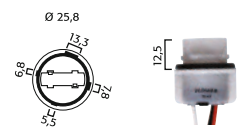
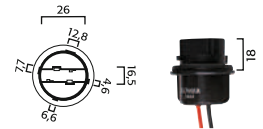

Type	i		
3444	holder for bulbs with socket W2,5x16d with cable	10	150
3644	holder for bulbs with socket W2,5x16q with cable	10	150
4041	holder for bulbs with socket BA9s with cable	10	400
4244	holder for wedge base bulbs with socket W2,1x9,5d	10	1200
4245	holder for bulbs with socket W2,1x9,5d with cable	10	500
4144	holder for bulbs with socket W2x4,6d with cable	10	500



Mini relay sockets

Type	i		
2222	for all relays with 6,3 mm pins	10	300
222210	with 5 cables	1	100
222205	with pins	1	100
2223	for high power relays	10	200
222310	with 5 cables	1	100
222305	with pins	1	100
2224	for high power change over relays	10	200
222410	with 5 cables	1	100
222405	with pins	1	100

Micro relay sockets

Type	i		
1122	no bracket	10	250
1123	with bracket	10	250
112310	with cable	10	100
112305	with pins	10	100

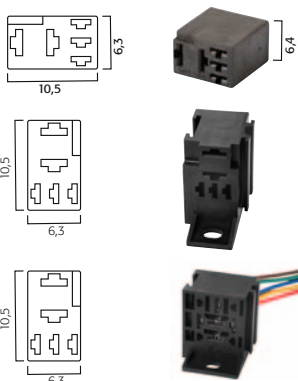
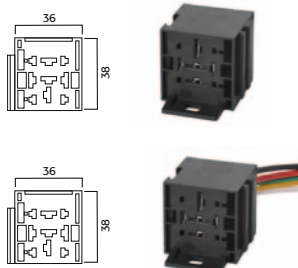
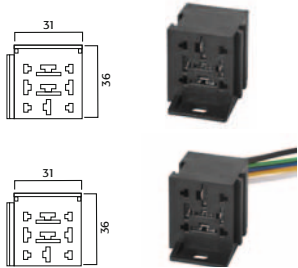
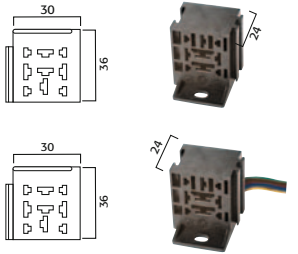



Spare lamp kits

Type	i			
8004	1x H4 625543 1x P21W 6671 1x R5W 4025 1x C5W 4033	1x PY21W 667101 Amber 1x P21/5W 5229 1x T4W 4088 2x 2148xx	1	36
8017	1x H1 3021 1x 6671 1x 5229 1x 4033 4x 2148xx	1x H7 2070 1x 667101 Amber 1x 4025 1x 429101	1	36
8007	1x H7 2070 1x P21W 6671 1x P21/5W 5229 1x W5W 4291	1x PY21W 667101 1x WY5W 429101 1x R5W 4025 2x 2148xx	1	36
8204	1x H4 625543 1x R5W 4025 1x 214810 1x 214820	1x P21W 6671 1x T4W 4088 1x 214815	1	56
8201	1x H1 3021 1x R5W 4025 1x 214810 1x 214820	1x P21W 6671 1x W5W 4291 1x 214815	1	56
8207	1x H7 2070 1x R5W 4025 1x 214810 1x 214820	1x PY21W 667101 Amber 1x WY5W 429101 Amber 1x 214815	1	56

other fittings on request





Spare lamp kits for trucks



Type	i			
8044	1x H4 825543 2x P21W 6652 1x T4W 4080 1x 214815	1x P21W/5W 5239 1x R5W 4052 1x C5W 4002 1x 214820	1	36
8405	2x H4 825543 2x P21/5W 5239 2x T4W 4080 blade fuses	4x P21W 6652 2x R5W 4052 2x C5W 4002	1	20
8407	2x H7 2470 2x P21/5W 5239 2x T4W 4080 blade fuses	4x P21W 6652 2x R5W 4052 2x C5W 4002	1	20
Andere Bestückung auf Anfrage				



Workshop kit



Type	i					
80200	assorted small bulbs				1	1
6924	12 V	0,5 W	W2x4,6d PVC	10		
449103	12 V	1,1 W	BX8,4d	10		
419101	12 V	1,2 W	B8,5d	10		
419102	12 V	1,2 W	B8,3d	10		
419103	12 V	1,2 W	BX8,4d	10		
449101	12 V	1,2 W	BX8,5d	10		
6925	12 V	1,2 W	W2x4,6d PVC	10		
479103	12 V	1,3 W	BX8,4d	10		
449105	14 V	1,4 W	HRQ	5		
459101	12 V	1,5 W	BX8,4d	10		
459103	12 V	1,5 W	BX8,4d	10		
183385	12 V	1,8 W	EBS	5		
439101	12 V	2 W	B8,5d	10		
439102	12 V	2 W	B8,3d	10		
439103	12 V	2 W	BX8,4d	10		
479101	12 V	2 W	BX8,5d	10		
409080	12 V	3 W	B10d Halogen	2		
4591	12 V	3 W	T6,5	10		



Accessories

Fuse kit



Type	i					
213050	blade fuses fusibles plats				1	1
314820	32 V	20 A	yellow	2		
314830	32 V	30 A	green	2		
314840	32 V	40 A	orange	2		
314850	32 V	50 A	red	2		
314860	32 V	60 A	light blue	2		
214805	32 V	5 A	light brown	10		
214875	32 V	7,5 A	brown	10		
214810	32 V	10 A	red	10		
214815	32 V	15 A	light blue	10		
214820	32 V	20 A	yellow	10		
214825	32 V	25 A	white	10		
214830	32 V	30 A	green	10		
514875	32 V	7,5 A	brown	10		
514810	32 V	10 A	red	10		
514815	32 V	15 A	light blue	10		
514820	32 V	20 A	yellow	10		
514825	32 V	25 A	white	10		
514830	32 V	30 A	green	10		



Fuse kit



Type	i				
213010	small blade fuses			1	1
514802	32 V	2 A	grey	10	
514803	32 V	3 A	violet	10	
514804	32 V	4 A	pink	10	
514805	32 V	5 A	light brown	10	
514875	32 V	7,5 A	brown	10	
514810	32 V	10 A	red	10	
514815	32 V	15 A	light blue	10	
514820	32 V	20 A	yellow	10	
514825	32 V	25 A	white	10	
514830	32 V	30 A	green	10	
16552	blade fuse puller			1	



fuses are in accordance with norms DIN 72581/3, SAE J2077, SAE J1284, SAE J1888, JASO D612 bzw. ISO DIS 8820-3.

Accessories

Fuse kit

Type	i				
213020	jap. miniature blade fuses			1	1
503802	58 V	2 A	grey	10	
503803	58 V	3 A	violet	10	
503804	58 V	4 A	pink	10	
503805	58 V	5 A	light brown	10	
503875	58 V	7,5 A	brown	10	
503810	58 V	10 A	red	10	
503815	58 V	15 A	light blue	10	
503820	58 V	20 A	yellow	10	
503825	58 V	25 A	white	10	
503830	58 V	30 A	green	10	
16552	blade fuse puller			1	







Fuse kit

Type	i				
213040	blade fuses			1	1
214801	32 V	1 A	black	5	
214802	32 V	2 A	grey	5	
214803	32 V	3 A	violet	10	
214804	32 V	4 A	pink	10	
214805	32 V	5 A	light brown	10	
214875	32 V	7,5 A	brown	10	
214810	32 V	10 A	red	10	
214815	32 V	15 A	light blue	10	
214820	32 V	20 A	yellow	10	
214825	32 V	25 A	white	10	
214830	32 V	30 A	green	10	
214840	32 V	40 A	orange	10	
16552	blade fuse puller			1	



Fuse kit



Type	i					
213070	blade fuses				1	1
514803	32 V	3 A	violet	5		
514805	32 V	5 A	light brown	5		
514875	32 V	7,5 A	brown	5		
514810	32 V	10 A	red	20		
514815	32 V	15 A	light blue	20		
514820	32 V	20 A	yellow	20		
514825	32 V	25 A	white	15		
514830	32 V	30 A	green	20		
214805	32 V	5 A	light brown	10		
214875	32 V	7,5 A	brown	10		
214810	32 V	10 A	red	30		
214815	32 V	15 A	light blue	30		
214820	32 V	20 A	yellow	20		
214825	32 V	25 A	white	20		
214830	32 V	30 A	green	20		
214840	32 V	40 A	orange	5		







Fuse kit

Type	i				
314820	32 V	20 A	yellow	8	
314830	32 V	30 A	green	8	
314840	32 V	40 A	orange	8	
314850	32 V	50 A	red	8	
314860	32 V	60 A	light blue	8	
314870	32 V	70 A	brown	8	
314880	32 V	80 A	white	8	
3148100	32 V	100 A	violet	5	
503802	58 V	2 A	grey	5	
503803	58 V	3 A	violet	5	
503804	58 V	4 A	pink	5	
503805	58 V	5 A	light brown	10	
503875	58 V	7,5 A	brown	15	
503810	58 V	10 A	red	20	
503815	58 V	15 A	light blue	20	
503820	58 V	20 A	yellow	20	
503825	58 V	25 A	white	15	
503830	58 V	30 A	green	15	







Accessories

Sales displays

Type	i		
 18810	Sales display for standard bulbs WITHOUT BULBS	1	1
 18812	Sales display for ultra bulbs WITHOUT BULBS	1	1

Sales displays

Type	i		
<p>18900</p> <p>183000</p>	<p>metallic lamp cabinet including tester</p>    <p>delivery without bulbs</p>	<p>1</p>	<p>1</p>







Product index

in numerical order by type





Product index

Car bulbs

Type	V	W		ECE	lm	B3	Tc		P.
561	12,8	12 CP	Rigid Loop		114 -188			1000	55
606	6	0,6	E10	C0,6W					55
624	6	2,4	E10	C2,4W					55
660	6	6	E10		50 +-30%	100	300		55
880	12	27	PG13	H27W/1					29
881	12	27	PGJ13	H27W/2					29
885	12	50	PG13		1250 +-12%			B50=200	29
886	12	50	PGJ13		1250 +-12%			B50=200	29
890	12	27	PG13		540 +-12%			T50=300	29
893	12	37,5	PG13		940 +-12%	140	230	14V	29
894	12	37,5	PGJ13		940 +-12%	140	230	14V	29
896	12	37,5	PGJ13		940 +-12%	140	230	14V	29
906	13	6 CP	W2,1x9,5d	T15	64,1-86,7			B50=1000	47
921	12	16	W2,1x9,5d	W16W, T15					47
1151	12	25	P15s-25-1						34
1181	12	18/18	P15d-25-1						34
1251	12	25/25	P15d-25-1						34
1351	12	35/35	P15d-25-1						34
1421	12	3	BA15s						41
2000	12	15	P26s	S3					35
2001	12	20	P26s						35
2002	12	25	P26s						35



Car bulbs

Type	V	W		ECE	lm	B3	Tc		P.
2015	12	15	P26s	S3	240 +-15%	70	100		31
2038	12	4	BA9s		17,6 -32,7			500	43
2070	12	55	PX26d	H7	1500 +-10%	330	550		20
2080	12	35	PGJ19-1	H8	800 +-15%	400	800		22
2090	12	65	PGJ19-5	H9	2100 +-10%	300	500		22
2110	12	55	PGJ19-2	H11	1215 -1485	800	1400		23
2114	24	70	PGJ19-2	H11	1600 +-10%	500	1000		23
2190	12	21	W3x16d	W21W, T20	460 +-69			300	47
2251	12	25/25	P15d-25-1	M5	600/550 +-15%	150	300		31
2351	12	35/35	P15d-25-1	M5	750/750 +-15%	75/75	200/200		31
2353	12	35/35	P15d-25-3	M5	750/750 +-15%	75/75	200/200		31
2470	24	70	PX26d	H7	1750 +-10%	220	500		20
2690	12	21/5	W3x16q	W21/5W, T20	440 +-66 / 35 +-7			500/1000	47
3008	24	3	BA9s						42
3021	12	55	P14,5s	H1	1550 +-232	400	650		17
3024	24	70	P14,5s	H1	1900 +-15%	400	650		17
3038	12	3	BA9s		28 +-15%	250	500		42
3057	12,8	32/2 CP	W2,5y16q						39
3130	6	45/40	P45t	R2	720				34
3131	6	35/35	BA20d	S2	650/465 +-20%	100	250		35
3156	12	27	W2,5x16d	P27W		1200	5000		37
3157	12	27/7	W2,5y16q	P21/7W		1200	5000		39





Product index

Car bulbs

Type	V	W		ECE	lm	B3	Tc		P.
3223	6	25/25	BA20d	S1	435/315 +-20%	100	250		35
3265	6	15/15	BA20d		250/190 +-20%	100	250		35
3320	12	55	PK22s	H3	1450 +-218	400	650		19
3324	24	70	PK22s	H3	1750 +-15%	400	650		19
3329	12	35	BA20s	F2					34
3348	48	45	PK22s	H3	960 +-10%	204	229		19
3350	12	50	BA20s						34
3380	80	55	PK22s	H3	1050 +-15%	215	258		19
3440	24	35	BA20s	F2					34
3720	24	70	X511	H2	1828-2472	90	250		18
3770	24	55/50	P45t	R2	1000	90	180		34
3923	12	25/25	BA20d	S1	435/315 +-20%	100	250		35
3939	12	35/35	BA20d	S2	650/465 +-20%	70	200		35
3940	12	45/40	P45t	R2	860	100	220		34
4000	24	15	P26s						35
4002	24	5	SV8,5	C5W	36-54			B50=200	52
4005	12	5	BA9s		12,5 +-15%	1000	1600		32
4006	12	6	BAX9s	H6W	125 +-12%	600	1000		32
4008	24	2	BA9s		19 +-15%	1000	1600		42
4010	12	10	BA9s		200 +-10%	300	600		32
4020	12	20	BA9s		470 +-10%	300	600		32
4023	6	5	BA15s	R5W	40-60			Tn=200	40



Car bulbs

Type	V	W		ECE	Im	B3	Tc		P.
4025	12	5	BA15s	R5W	40-60	150	400		40
4032	12	5	SV8,5		45 +-20%	100	300		52
4033	12	5	SV8,5	C5W	36-54			Tn=200	52
4038	12	2	BA9s		12,5 +-15%	1000	1600		42
4039	6	2	BA9s						42
4043	6	2	E10						43
4045	12	3	E10					2000	43
4046	24	3	E10					2000	43
4048	24	3	BA7s		7,5 -19,5			Tn=300	43
4049	6	0,6	BA7s						43
4050	6	1,2	BA7s						43
4051	12	2	BA7s		8,0 -14,0			Tn=200	43
4052	24	5	BA15s	R5W	40-60	100	300		40
4071	12	21	BA15s		224 -336	350	740		41
4080	24	4	BA9s	T4W	35 +-15%	500	1250		42
4085	12	5	BA9s		35 +-30%	150	500		43
4088	12	4	BA9s	T4W					42
4089	6	4	BA9s	T4W	28 -42			Tn=300	42
4090	12	3	W2,1x9,5d	W3W	15,4-28,6	750	1500		45
4092	24	3	W2,1x9,5d	W3W	22 +-20%	400	3000		45
4096	6	3	W2,1x9,5d	W3W					46
4191	12	1,2	W2x4,6d	T5	6			B50=1000	44





Product index

Car bulbs

Type	V	W		ECE	lm	B3	Tc		P.
4192	24	1,2	W2x4,6d	T5	6,38 +-25%	400	2000		45
4196	6	1,2	W2x4,6d	T5					44
4203	6	10	SV8,5						54
4206	24	5	SV8,5		36-54			Tn=200	54
4210	24	10	SV8,5		76,5-103,5			Tn=200	54
4215	24	15	SV8,5		170-230			Tn=75	54
4218	24	18	SV8,5		240			Tn=75	54
4230	12	5	SV8,5		36-54			Tn=200	54
4231	12	10	SV8,5		100-150	400	800		54
4290	12	2	W2,1x9,5d	W2W	13,5 +-20%	500	1800		46
4291	12	5	W2,1x9,5d	W5W	40-60	600	1000		45
4292	24	5	W2,1x9,5d	W5W	50 +- 20%	800	3000		45
4391	12	2	W2x4,6d	T5	12 +-30%	300	1000		44
4425	12	5	BA15d	R5W	40-60	150	400		42
4452	24	5	BA15d	R5W	40 - 60	100	300		42
4490	12	10	W2,1x9,5d	T13	120 +-14			400	46
4496	6	10	W2,1x9,5d	T13	120 +-14			400	46
4590	12	3	W2x4,6d	T5					45
4591	12	3	W2x4,6d	T6,5	22 +-30%	80	200		45
4652	24	18	BA15s		250		400		36
4670	6	18	BA15s						36
4671	12	18	BA15s		250			B50=75	36



Car bulbs

Type	V	W		ECE	lm	B3	Tc		P.
4691	12	2,3	W2x4,6d	W2,3W					44
4891	12	5	W2,1x9,5d	W5W	50 +-20%	1800	3600		33
5148	12	3	SV5,5		30 +-30%	50	150		51
5149	24	3	SV5,5		17,5 +-30%	50	150		51
5157	6	3	SV7						51
5158	12	3	SV7		30 +-30%	100	300		51
5159	24	3	SV7		17,5 +-30%			300	51
5168	12	10	SV8,5		105 +-30%			300	52
5209	12	18/5	BAY15d						38
5219	12	21/5	BA15d		440/35 +-15%	100/600	250/1600		39
5226	6	10/3	BAY15d						38
5227	12	10/5	BAY15d						38
5228	6	21/5	BAY15d	P21/5W	440 +-15%/35 +-20%	60/160	600/1600		38
5229	12	21/5	BAY15d	P21/5W	440/35 +-15%	100/600	250/1600		38
5230	12	32/4 CP	BAY15d		440/35 +-15%	100/600	250/1600		38
5238	24	21/5	BA15d		440/40 +-15%	150/600	400/1600		39
5239	24	21/5	BAY15d	P21/5W	440/40 +-15%	150/600	400/1600		38
5249	24	25/5	BAY15d		374-506/32-48	350/1000	750/2000		38
5329	12	21/4	BAZ15d	P21/4W	374-506/12-18	250/600	480/2000		39
5338	12	25	BA15s						34
5339	24	21/4	BAZ15d	P21/4W	440/20 +-30%	60/160	600/1600		39
5652	24	15	BA15s		162-218	100	218		36



Product index



Car bulbs

Type	V	W		ECE	lm	B3	Tc		P.
5671	12	15	BA15s		210			B50=75	36
6000	6	15	P26s	S3					35
6021	12	21	BAY9s	H21W	600 +-12%	250	500		32
6024	6	2,4	PX13,5s	HS3		250	500		55
6127	6	1	SV5,5						51
6137	6	1,2	SV5,5						51
6158	12	3	SV7		30 +-30%			150	51
6159	24	3	SV7						51
6251	6	25/25	P15d-25-1						34
6421	24	21	BAY9s	H21W	600 +-12%	200	400		32
6441	24	1	W2x4,6d						50
6640	24	45	BA15s	Form U					34
6652	24	21	BA15s	P21W	391-529	350	750		36
6654	24	21	BA15d		391-529	350	750		37
6670	6	21	BA15s	P21W	460 +-15%			100	36
6671	12	21	BA15s	P21W	391-529	350	740		36
6674	12	21	BA15d		391-529	350	740		37
6678	12	21	BAU15s		280 +-20%	120	320		37
6743	24	45/40	BA20d		860/675 +-20%	100	250		35
6924	12	0,5	W2x4,6d						50
6925	12	1,2	W2x4,6d						50
8652	24	25	BA15s						36

Product index





Car bulbs

Type	V	W		ECE	lm	B3	Tc		P.
8671	12	25	BA15s						36
9003	12	60/55	P43t	H4	1650 /1000 +-15%	250/400	500/900		14
9004	12	65/45	P29t	HB1	1200/700			173/368	25
9005	12	60	P20d	HB3	1860 +-12%	330	700		26
9006	12	51	P22d	HB4	1095 +-15%	1000	2200		27
9007	12	65/55	PX29t	HB5	1350/1000 +-15%	50/100	150/250	14V	28
9008	12	60/55	P26,4t	H13	1700/1100		320/1600	B10=150/1200	24
9011	12	65	PX20d	HIR1	2500 +-15%	220	300		28
9012	12	55	PX22d	HIR2	1875 +-15%	500	900		28
9055	12	53	PZ20d	H12					24
9076	12	70	P22d	HB4 Rally	1650 +-15%	80	180	14V	27
9086	12	80	P22d	HB4 Super Rally	2000 +-15%	80	180	14V	27
9104	12	100/80	P29t	HB1 Rally	1600/1300			86/173	25
9105	12	100	P20d	HB3 Rally	2650 +-12%	40	100		26
9107	12	100/80	PX29t	HB5 Rally	2000/1600 +-15%	50/100	150/300	14V	28
9108	12	100/80	P26,4t	H13 Rally					24
9145	12	42	PY20d	H10	850 +-15%	1500	2800		22
9629	48	25/10	BAY15d						38
9671	48	25	BA15s						56
9921	12	16	W2,1x9,5d	W16W, T15					47
12070	12	80	PX26d	H7 Rally	1900 +-10%	150	300		21
12080	12	65	PGJ19-1	H8 Rally	1730	700	1000		22



Product index



Car bulbs

Type	V	W		ECE	lm	B3	Tc		P.
12110	12	90	PGJ19-2	H11 Rally	1961	200	400		23
13020	12	100	P14,5s	H1 Rally	2210-2990			Tn=100	18
13024	24	100	P14,5s	H1 Rally					18
13130	12	130	P14,5s	H1 Super Rally					18
13320	12	100	PK22s	H3 Rally					19
13324	24	100	PK22s	H3 Rally					19
13330	12	130	PK22s	H3 Super Rally	1800 +-10%	487	532		19
14023	6	10	BA15s	R10W	100-150			B50 = 200	41
14025	12	10	BA15s	R10W	100-150	300	600		41
14052	24	10	BA15s	R10W	100-150	200	500		41
14425	12	10	BA15d	R10W	100-150	300	600		42
14452	24	10	BA15d	R10W	100-150	200	500		42
15025	12	15	BA15s						41
24540	12	45/40	BA20d		860/675 +-20%	100	250		35
27140	24	30 mA	W2x4,6d	T5					45
27141	24	1	W2x4,6d	T5					45
40722	12	25	Pk32d-7	D5S	2000 + 300 -200	2500	4000		13
40822	42	25	Pk32d-1	D8S	2000 +- 300	2500	4000		13
42322	42	35	Pk32d-5	D3S	3200 +-450	1500	2500		12
42326	42	35	Pk32d-6	D3R	2800 +-450	1500	2500		12
42422	42	35	P32d-5	D4S	3200 +-450	2000	3000		12
42426	42	35	P32d-6	D4R	2800 +-450	1500	2500		13

Product index





Car bulbs

Type	V	W		ECE	lm	B3	Tc		P.
42522	42	35	Pk32d-5	D3S	3200 +-450	1500	2500		12
85409	85	35	Pk32d-3	D1R	2800 +-450	2000	3000		12
85410	85	35	Pk32d-2	D1S	3200 +-450	2000	3000		12
85422	85	35	P32d-2	D2S	3400 +-450	1500	2500		12
85426	85	35	P32d-3	D2R	2800 +-250	1500	2500		13
85510	85	35	Pk32d-2	D1S	3200 +-450	1500	2500		12
85522	85	35	P32d-2	D2S	3100 +-250	1500	2500		12
85526	85	35	P32d-3	D2R	2700 +-250	1500	2500		13
92070	12	55	PX26d	H7	1500 +-10%	330	550		20
92080	12	35	PGJ19-1	H8	800 +-15%	400	800		22
92090	12	65	PGJ19-5	H9	2100 +-10%	300	500		22
92107	12	16	W2,1x9,5d	T15					47
92110	12	55	PGJ19-2	H11	1215-1485	800	1400		23
92145	12	145/100	P43t	H4 Super Rally	2850-3720/1224-1836	50	100		15
92190	12	21	W3x16d	W21W T20	460 +-69			300	78
92690	12	21/5	W3x16q	W21/5W T20	440 +-66/35 +-7			500/1000	78
93021	12	55	P14,5s	H1	1550 +-232	400	650		17
93156	12	27	W2,5x16d	P27W		1200	5000		37
93157	12	27/7	W2,5y16q	P21/7W		1200	5000		39
93320	12	55	PK22s	H3	1450 +-218	400	650		19
93939	12	35/35	BA20d	S2	650/465	+ - 20%	70	200	35
94025	12	5	BA15s	R5W	40-60	150	400		40





Product index

Car bulbs

Type	V	W		ECE	lm	B3	Tc		P.
94033	12	5	SV8,5	C5W	36-54			Tn=200	52
94088	12	4	BA9s	T4W					42
94191	12	1,2	W2x4,6d	T5	6			B50= 1000	44
94231	12	10	SV8,5		100-150	400	800		54
94291	12	5	W2,1x9,5d	W5W	40-60	600	1000		45
95229	12	21/5	BAY15d	P21/5W	440/35 +-15%	100/600	250/1600		38
96671	12	21	BA15s	P21W	391-529	350	740		36
99004	12	65/45	P29t	HB1	1200/700				25
99005	12	60	P20d	HB3	1860 +-12%				26
99006	12	51	P22d	HB4	1095 +-15%	1000	2200		27
99007	12	65/55	PX29t	HB5	1350/1000 +-15%	50/100	150/250	14V	28
181471	24	1,2	EBS R6		7,5 +-30%	500	1000		49
181649	12	1,2	SG8-5,5d						50
181791	24	1,2	EBS R4						49
183385	12	1,8	EBS R11		6,5 +-30%	500	1500		49
183527	24	1,2	EBS R10						49
188328	24	1,2	EBS N10		7,5 +-30%	500	1000		49
191219	12	19	PGJ19-3	H16	500 +-10%	1150	2000		24
200033	12	15	P26s						35
207022	12	55	PX26d	H7	1500 +-10%	500	1000		20
211022	12	55	PGJ19-2	H11	1350 +-10%	1000	2000		23
219007	12	21	WX3x16d	W21W, T20	280 +-56			300	47



Car bulbs

Type	V	W		ECE	lm	B3	Tc		P.
225112	12	25/25	P15d-25-1	M5					31
235112	12	35/35	P15d-25-1	M5	750/750 +-15%	75/75	200/200		31
235312	12	35/35	P15d-25-3	M5	750/750 +-15%	75/75	200/200		31
247022	24	70	PX26d	H7	1750 +-10%	500	1000		20
269007	12	21/5	W3x16q	W21/5W, T20	270 +-81 / 20 +-6			500/1000	47
302122	12	55	P14,5s	H1					17
302422	24	70	P14,5s	H1	1900 +-15%	600	1200		17
315601	12	27	W2,5x16d						37
315701	12	27/7	W2,5y16q	PY21/7W		1200	5000		39
323023	12	35/30	P23t	HS5	620/515 +-12%	250	500		30
323543	12	35/35	PX43t	HS1	825/525 +-15%	100/200	200/400		30
332422	24	70	PK22s	H3	1680 +-10%	587	632		19
375701	12,8	2,1/0,59 A	WX2,5x16q						39
377002	24	75/75 CP	P45t		1000	90	180		34
392380	12	25/25	BA20d		600/550 +-15%	150	300		30
393980	12	35/35	BA20d		750/550 +-15%	150	300		30
393982	12	35/35	BA20d	S2	372-558/520-780		700		30
394002	12	75/75 CP	P45t		860	100	220		34
400115	6	15	SV8,5						54
400118	6	18	SV8,5						54
400210	24	10	SV8,5		105 +-30%		300		53
400233	24	5	SV8,5						53



Product index



Car bulbs

Type	V	W		ECE	lm	B3	Tc		P.
400415	12	15	SV8,5		197-267	40	75		54
400418	12	18	SV8,5		240			Tn=75	54
400421	12	21	SV8,5	C21W					54
400601	12	6	BAZ9s	HY6W	75 +-17%	400	800		32
400633	12	6	BAX9s	H6W	125 +-12%	250	500		32
402509	12	5	BA15s						40
402533	12	5	BA15s						40
403310	12	10	SV8,5		105 +-30%		300		53
403333	12	5	SV8,5						53
403334	12	5	SV8,5						53
405233	24	5	BA15s						40
405299	24	5	BA15s	R5W	50 +-15%	400	1000		40
408035	24	4	BA9s						43
408099	24	4	BA9s	T4W	35 +-15%	500	1250		42
408835	12	4	BA9s						43
409080	12	3	B10d		20 +-30%	300	1000		50
419101	12	1,2	B8,5d		6,38 +-25%	500	1000		48
419102	12	1,2	B8,3d						48
419103	12	1,2	BX8,4d		7,5 +- 20%	600	3000		49
419104	12	1,2	B8,7d						50
419106	12	1,2	W2x4,6d	T5					44
419107	12	1,2	W2x4,6d	T5					44

Product index





Car bulbs

Type	V	W		ECE	lm	B3	Tc		P.
419116	12	30 mA	W2x4,6d	T5					44
419122	12	1,2	W2x4,6d	T5					44
419134	12	1,2	W2x4,6d	T5					44
419201	24	1,2	B8,5d		6,38 +-25%	400	2000		48
419202	24	1,2	B8,3d						48
419301	24	1,2	BX8,5d		6,38 +-25%	400	2000		48
429101	12	5	W2,1x9,5d	WY5W	24-36	1500	3000		45
429122	12	5	W2,1x9,5d	W5W T10 LL	50 +-20%	850	2000		45
429133	12	5	W2,1x9,5d	W5W	50 +-20%	100	300		45
429180	12	5	B10d						50
429209	24	5	W2,1x9,5d	T10					46
429234	24	5	W2,1x9,5d	T10					46
429235	24	5	W2,1x9,5d	T10					46
439101	12	2	B8,5d		10,2 +-25%	1300	4000		48
439102	12	2	B8,3d						48
439103	12	2	BX8,4d						49
439104	12	1 CP	B11d-T7						50
449007	12	10	W2,1x9,5d	T13	75 +-30%	100	300		46
449101	12	1,2	BX8,5d		6,38 +-25%	500	2000		48
449103	12	1,1	BX8,4d		3,55 +-25%	500	5000		49
449105	12	1,4	HRQ						50
459101	12	1,5	BX8,5d		6 +-20%	1000	6500		48



Product index



Car bulbs

Type	V	W		ECE	lm	B3	Tc		P.
459103	12	1,5	BX8,4d		6,5 +-20%	1700	6500		49
469101	12	2,3	W2x4,6d	WY2,3W					44
479101	12	2	BX8,5d						48
479103	12	1,3	BX8,4d		6,5 +-20%	1300	6000		49
489133	12	5	W2,1x9,5d	W5W					33
516835	12	10	SV8,5						52
522902	12	21/5	BAW15d	PR21/5W	105/8 +-20%	450/800	1000/2000		39
522907	12	21/5	BAY15d		216-324/20-34	250/1000	480/2000		38
523908	24	21/5	BAY15d						38
525543	12	100/55	P43t	H4 Rally					15
551523	12	55/15	PGJ23-1	H15	1350/260 +-10%	250/2000	500/4000		24
602023	24	60/20	PGJ23-1	H15					24
602101	12	21	BAW9s	HY21W	300 +-17%	200	400		32
625522	12	60/55	P43t	H4	1403-1897/850-1150	900	1600		14
625536	12	60/55	P36t	H4	1650/1000 +-25%	150	400		16
625543	12	60/55	P43t	H4	1650 /1000 +-15%	250/400	500/900		14
625545	12	60/55	P45t	H4	1650/1000	350	700		16
665201	24	21	BAU15s	PY21W	224-336	890	1590		37
665207	24	21	BA15s		391-529	350	750		36
665208	35	21	BA15s						36
665299	24	21	BA15s	P21W	391-529	150	350		36
667101	12	21	BAU15s	PY21W	224-336	890	1590		37

Product index



Car bulbs

Type	V	W		ECE	lm	B3	Tc		P.
667102	12	21	BAW15s	PR21W	110 +-20%	250	600		37
667107	12	21	BA15s		224-336	350	740		36
667133	12	21	BA15s						36
725543	12	100/90	P43t	H4 Rally	2900/1700	80	200		15
725545	12	100/90	P45t	H4 Rally	2900/1700	80	200		16
825522	24	75/70	P43t	H4	1615-2185/1020-1380	340/800	700/1600		14
825543	24	75/70	P43t	H4	1900/1200 +-15%	180	500		14
825545	24	75/70	P45t	H4	1900/1200 +-15%	180	500		16
912190	12		W3x16d	W21W LED	250 +-20%		29200*		75
912197	12		WX3x16d	WY21W LED	250 +-20%		29200*		75
912198	12		W3x16d	W21W LED	80 +-20%		29200*		73
912510	12		P43t	H4 LED					70
912690	12		W3x16q	W21/5W LED	250/65 +-20%		29200*		75
912697	12		W3x16q	WY21/5W LED	50/150 +-20%		29200*		75
912698	12		W3x16q	W21/5W LED	60/20 +-20%		29200*		75
914020	12-24		BA15s	R5W LED			29200*		72
914025	12	10	BA15s	R10W	100-150	300	600		41
914028	12-24		BA15s	R5W LED			29200*		72
914030	12-24		SV8,5	C5W LED				17520	72
914031	12-24		SV8,5	C5W LED				17520	72
914140	12		PX26d	H7 LED					70
914231	12-24		SV8,5	K type LED				17520	72

*10y at 8h days



Product index

Car bulbs



Type	V	W		ECE	lm	B3	Tc		P.
914290	12-24		W2,1x9,5d	W5W LED			29200*		73
914293	12-24		W2,1x9,5d	W5W LED			29200*		73
914880	12		PGJ19-X	H8 / H9 / H11 / H16 LED					70
915168	12-24		SV8,5	5168 type LED				17520	72
915220	12		BAY15d	P21/5W LED			29200*		74
915227	12		BAY15d	P21/5W LED			29200*		74
915228	12		BAY15d	P21/5W LED			29200*		74
915238	24		BAY15d	P21/5W LED			29200*		74
915239	24		BAY15d	P21/5W LED			29200*		74
916652	24		BA15s	P21W LED			29200*		73
916658	24		BA15s	P21W LED			29200*		73
916670	12-24		BA15s	P21W LED			29200*		73
916677	12		BA15s	P21W LED			29200*		73
916678	12		BA15s	P21W LED			29200*		73
925543	12	130/90	P43t	H4 Super Rally					15
925545	12	130/90	P45t	H4 Super Rally	3600/1900 +-15%	40	100		16
1332033	12	100	PK22s	H3 Rally	985 +-10%	479	504		19
1402501	12	10	BAU15s	RY10W	75 +-10%	400	1000		41
1402507	12	10	BA15s		100-150	300	600		40
1402509	12	10	BA15s						40
1402533	12	10	BA15s						40
1405299	24	10	BA15s	R10W	125 +-15%	400	1000		41

*10y at 8h days

Product index





Car bulbs

Type	V	W		ECE	lm	B3	Tc		P.
2070100	12	55	PX26d	H7	1500 +-10%	200	400		20
2070180	12	55	PX26d	H7	1350-1650	175	350		20
2070300	12	55	PX26d	H7	1350-1650	125	250		20
2070333	12	55	PX26d	H7	1500 +-10%	180	400		20
2070335	12	70	PX26d	H7 Rally	900 +-15%	200	400		21
2070600	12	55	PX26d	H7	1350-1650	125	250		20
2070670	12	70	PX26d	H7 Rally	900 +-15%	200	400		21
2070680	12	55	PX26d	H7	1500 +-10%	300	500		20
2070890	12	55	PX26d	H7	1500 +-10%	300	500		20
2070900	12	55	PX26d	H7	1350-1650	175	350		20
2074205	12	5	G4						33
2074210	12	10	G4						33
2074220	12	20	G4						33
2074410	24	10	G4						33
2074420	24	20	G4						33
2080335	12	50	PGJ19-1	H8 Rally	1250 +-10%	350	450		22
2110333	12	55	PGJ19-2	H11	1246 +-10%	400	850		23
2110335	12	70	PGJ19-2	H11 Rally	658	300	500		23
2110900	12	55	PGJ19-2	H11	1215-1485	175	350		23
3021180	12	55	P14,5s	H1	1318-1782	175	350		17
3021300	12	55	P14,5s	H1	1318-1782	125	250		17
3021333	12	55	P14,5s	H1	1550 +-15%	200	350		17



Product index

Car bulbs

Type	V	W		ECE	lm	B3	Tc		P.
3021335	12	70	P14,5s	H1 Rally	870 +-10%	457	518		18
3021600	12	55	P14,5s	H1	1318-1782	125	250		17
3021670	12	70	P14,5s	H1 Rally					18
3021680	12	55	P14,5s	H1					17
3021890	12	55	P14,5s	H1					17
3021900	12	55	P14,5s	H1	1318-1782	175	350		17
3235333	12	35/35	PX43t	HS1					30
3320333	12	55	PK22s	H3	1280 +-10%	680	722		19
3320335	12	70	PK22s	H3 Rally	850 +-10%	462	504		19
3320666	12	55	PK22s	H3	1240 +-10%	652	714		19
3320900	12	55	PK22s	H3	1450 +-15%	150	300		19
6230043	12	60/55	P43t	H4	1403-1897/850-1150	125/125	250/250		14
6255180	12	60/55	P43t	H4	1403-1897/850-1150	125/175	250/350		14
6255333	12	60/55	P43t	H4	1650/1000 +-15%	250/400	500/900		14
6255600	12	60/55	P43t	H4	1403-1897/850-1150	125/125	250/250		14
6255680	12	60/55	P43t	H4					14
6289043	12	60/55	P43t	H4					14
6290043	12	60/55	P43t	H4	1403-1897/850-1150	125/175	250/350		14
7255333	12	100/90	P43t	H4 Rally					15
7255335	12	100/90	P43t	H4 Rally	1300/900 +-15%	120	250		15
7255670	12	100/90	P43t	H4 Rally	1300/900 +-15%	120	250		15
8213043	24	130/90	P43t	H4 Super Rally	3000-4000/1440-1760	450	900		15

Product index





Car bulbs

Type	V	W		ECE	lm	B3	Tc		P.
8290043	24	100/90	P43t	H4 Rally	1880-2820/1250-1691	80	200		15
8290045	24	100/90	P45t	H4 Rally	1880-2820/1250-1691	80	200		16
9003333	12	60/55	P43t	H4	1650/1000 +-15%	250/400	500/900		14
9004100	12	65/45	P29t	HB1					25
9004333	12	65/45	P29t	HB1	1200/700			92/230	25
9004777	12	65/45	P29t	HB1					25
9005333	12	60	P20d	HB3	1860 +-12%	330	700		26
9005900	12	60	P20d	HB3	1637-2038	100	200		26
9006333	12	51	P22d	HB4	1095 +-15%	120	250		27
9006335	12	60	P22d	HB4 Rally	658	300	500		27
9006900	12	51	P22d	HB4	1095 +- 15%	150	360		27
9007333	12	65/55	PX29t	HB5					28
9008333	12	60/55	P26,4t	H13					24
9104333	12	100/80	P29t	HB1 Rally	1400/1100			86/173	25
9210043	12	130/100	P43t	H4 Super Rally	3600 +-15%	40	100		15
9214533	12	145/100	P43t	H4 Super Rally	2230-3350/1100-1650			Tn=75	15
9625543	12	60/55	P43t	H4	1650/1000 +-15%	250/400	500/900		14
9667101	12	21	BAU15s	PY21W	224-336	890	1590		37
9725543	12	100/90	P43t	H4 Rally	2900/1700	80	200		15
38874933	12	26	PG18.5d-3	PSX26W	500 +-10%	3000	6000		60
38965433	12	16	PU20d/2	HPC16WY	180 +-20%	1200	2400		58
39196133	12	24	WP3,3x14,5/3	PW24W	500 +-10%	750	1500		59



Product index



Car bulbs

Type	V	W		ECE	lm	B3	Tc		P.
39200533	12	24	WP3,3x14,5/4	PWY24W SV	300 +-15%	1000	2000		59
39202933	12	24	WP3,3x14,5/4	PWY24W	300 +-15%	1200	2400		59
39398033	12	35/35	BA20d		420/300 +-15%	150	250		30
39621860	13,5	24	Hiper LCP HTR HPSSL2A						59
39623230	12	16	WP3,3x14,5/4	PW16W	300 +-15%	1500	3000		59
52735233	12	19	PG20/2	PSY19W	215			2400	60
69653033	12	19	PG20/1	PS19W	350			2300	60
69668433	12	24	PG20/4	PSY24W	300			2400	60
69672133	12	13	PG18.5-d1	P13W	250			8000	60
69676933	12	24	PG20/7	PSX24W	500			1500	61
69678333	12	24	PGU20/4	PY24W SV	300			2000	61
69690533	12	24	PGU20/4	PY24W	300			2400	61
70044233	12	24	PG20/3	PS24W FF	500 +-10%	750	1500		61
70379533	12	24	PG20/4	PSY24W SV+	300			2000	61
77715934	12	16	PU20d/1	HPC16W	300 +-10%	1500	3000		58
77715941	12	19	PU20d/3	HPC19W	350 +-15%	1000	2000		58
77715958	12	24	PU20d/6	HPC24WY	300 +-15%	1200	2400		58
91402501	12	10	BAU15s	RY10W	75 +-10%	400	1000		78
91414003				Canceller / CANBus Adapter for H7 LED					71
91488003				Canceller / CANBus Adapter for H8, H9, H11 and H16 LED					71

Product index



Car bulbs

Type	V	W		ECE	lm	B3	Tc		P.
92070300	12	55	PX26d	H7	1350-1650	125	250		20
92070900	12	55	PX26d	H7	1350-1650	175	350		20
92110900	12	55	PGJ19-2	H11	1215-1485	175	350		23
93021300	12	55	P14,5s	H1	1318-1782	125	250		17
93021900	12	55	P14,5s	H1	1318-1782	175	350		17
93320900	12	55	PK22s	H3	1450 +-15%	150	300		19
96230043	12	60/55	P43t	H4	1403-1897/850-1150	125/125	250/250		14
96290043	12	60/55	P43t	H4	1403-1897/850-1150	125/175	250/350		14
99005900	12	60	P20d	HB3	1637-2038	100	200		77
99006900	12	51	P22d	HB4	1095 +-15%	150	360		77
2080B	12	35	PGJY19-1	H8B					22
2090B	12	65	PGJY19-5	H9B	2100 +-10%	250	500		22
2110B	12	55	PGJ19-2	H11B	1350 +-10%	350	580		23
211-2	12,8	12 CP	Miniature Cap		151			1000	55
6671SV	12	21	BAU15s	PY21W	280 +-20%	250	500		37
795X	12	50	BA15s		1250 +-15%	100	200		33
9005XS	12	60	P20d	HB3A	1860 +-12%	250	500		26
9006XS	12	51	P22d	HB4A	1095 +-12%	1000	1700		27



Product index

Fuses

Type	V	A	i	P.
3201	32	1	Glass fuses, 6,3x32 mm	92
3203	32	3	Glass fuses, 6,3x32 mm	92
3204	32	4	Glass fuses, 6,3x32 mm	92
3205	32	5	Glass fuses, 6,3x32 mm	92
3210	32	10	Glass fuses, 6,3x32 mm	92
3215	32	15	Glass fuses, 6,3x32 mm	92
3220	32	20	Glass fuses, 6,3x32 mm	92
3225	32	25	Glass fuses, 6,3x32 mm	92
3230	32	30	Glass fuses, 6,3x32 mm	92
3240	32	40	Glass fuses, 6,3x32 mm	92
38030	32	30	Fuse strips	97
38040	32	40	Fuse strips	97
38050	32	50	Fuse strips	97
38060	32	60	Fuse strips	97
38080	32	80	Fuse strips	97
38100	32	100	Fuse strips	97
39030	32	30	Type HSB	97
39040	32	40	Type HSB	97
39050	32	50	Type HSB	97
39060	32	60	Type HSB	97
39080	32	80	Type HSB	97
39100	32	100	Type HSB	97

Type	V	A	i	P.
39110	32	110	Type HSB	97
39125	32	125	Type HSB	97
39150	32	150	Type HSB	97
39175	32	175	Type HSB	97
124805	32	5	Thermoplastic fuses, yellow	93
124808	32	8	Thermoplastic fuses, white	93
124816	32	16	Thermoplastic fuses, red	93
124825	32	25	Thermoplastic fuses, blue	93
124840	32	40 (25)	Thermoplastic fuses, blue	93
214800	32		Blade fuses assorted, Blister	84
214801	32	1	Blade fuses, black	84
214802	32	2	Blade fuses, grey	84
214803	32	3	Blade fuses, violet	84
214804	32	4	Blade fuses, pink	84
214805	32	5	Blade fuses, light brown	84
214810	32	10	Blade fuses, red	84
214815	32	15	Blade fuses, light blue	84
214820	32	20	Blade fuses, yellow	84
214825	32	25	Blade fuses, white	84
214830	32	30	Blade fuses, light green	84
214840	32	40	Blade fuses, orange	84
214875	32	7,5	Blade fuses, brown	84



Product index

Fuses

Type	V	A	i	P.
284801	80	1	80V blade fuses, black	85
284802	80	2	80V blade fuses, grey	85
284803	80	3	80V blade fuses, violet	85
284804	80	4	80V blade fuses, pink	85
284805	80	5	80V blade fuses, light brown	85
284810	80	10	80V blade fuses, red	85
284815	80	15	80V blade fuses, blue	85
284820	80	20	80V blade fuses, yellow	85
284825	80	25	80V blade fuses, natural	85
284830	80	30	80V blade fuses, green	85
284840	80	40	80V blade fuses, orange	85
284875	80	7,5	80V blade fuses, brown	85
314820	32	20	Big blade fuses, yellow	86
314825	32	25	Big blade fuses, grey	86
314830	32	30	Big blade fuses, green	86
314840	32	40	Big blade fuses, orange	86
314850	32	50	Big blade fuses, red	86
314860	32	60	Big blade fuses, light blue	86
314870	32	70	Big blade fuses, brown	86
314880	32	80	Big blade fuses, white	86
315805	32	5	MB fuses, 6 Pins, orange	98
315875	32	7,5	MB fuses, 6 Pins, brown	98

Type	V	A	i	P.
501805	32	5	Micro III blade fuses, light brown	89
501810	32	10	Micro III blade fuses, red	89
501815	32	15	Micro III blade fuses, light blue	89
501875	32	7,5	Micro III blade fuses, brown	89
502805	32	5	Micro II blade fuses, light brown	89
502810	32	10	Micro II blade fuses, red	89
502815	32	15	Micro II blade fuses, light blue	89
502820	32	20	Micro II blade fuses, yellow	89
502825	32	25	Micro II blade fuses, white	89
502830	32	30	Micro II blade fuses, green	89
502875	32	7,5	Micro II blade fuses, brown	89
503802	58	2	Low profile small blade fuses, grey	88
503803	58	3	Low profile small blade fuses, violet	88
503804	58	4	Low profile small blade fuses, pink	88
503805	58	5	Low profile small blade fuses, light brown	88
503810	58	10	Low profile small blade fuses, red	88
503815	58	15	Low profile small blade fuses, light blue	88
503820	58	20	Low profile small blade fuses, yellow	88
503825	58	25	Low profile small blade fuses, white	88
503830	58	30	Low profile small blade fuses, green	88
503875	58	7,5	Low profile small blade fuses, brown	88
513800	58		Low profile small blade fuses, assorted, Blister	88



Product index

Fuses

Type	V	A	i	P.
514800	32		Small blade fuses, assorted, Blister	87
514801	32	1	Small blade fuses, black	87
514802	32	2	Small blade fuses, grey	87
514803	32	3	Small blade fuses, violet	87
514804	32	4	Small blade fuses, pink	87
514805	32	5	Small blade fuses, light brown	87
514810	32	10	Small blade fuses, red	87
514815	32	15	Small blade fuses, light blue	87
514820	32	20	Small blade fuses, yellow	87
514825	32	25	Small blade fuses, white	87
514830	32	30	Small blade fuses, green	87
514875	32	7,5	Small blade fuses, brown	87
604830	32	30	Type B, pink	95
604840	32	40	Type B, green	95
604850	32	50	Type B, red	95
604860	32	60	Type B, yellow	95
604870	32	70	Type B, brown	95
604880	32	80	Type B, black	95
604900	32	100	Type B, blue	95
604920	32	120	Type B, white	95
604940	32	140	Type B, dark red	95
605020	32	20	Type AS, blue	95

Type	V	A	i	P.
605030	32	30	Type AS, pink	95
605040	32	40	Type AS, green	95
605050	32	50	Type AS, red	95
605060	32	60	Type AS, yellow	95
607030	32	30	Type C, pink	96
607040	32	40	Type C, green	96
607050	32	50	Type C, red	96
607060	32	60	Type C, yellow	96
607080	32	80	Type C, black	96
608525	32	25	Type D, brown	96
608530	32	30	Type D, green	96
608715	12	15	Type JMS, grey	94
608720	12	20	Type JMS, blue	94
608725	12	25	Type JMS, white	94
608730	12	30	Type JMS, pink	94
608740	12	40	Type JMS, green	94
608750	12	50	Type JMS, red	94
608760	12	60	Type JMS, yellow	94
608815	32	15	Type J micro, grey	94
608820	32	20	Type J micro, blue	94
608825	32	25	Type J micro, light grey	94
608830	32	30	Type J micro, pink	94



Product index

Fuses

Type	V	A	i	P.
608840	32	40	Type J micro, green	94
608920	32	20	Type J small, blue	93
608925	32	25	Type J small, light grey	93
608930	32	30	Type J small, pink	93
608940	32	40	Type J small, green	93
608950	32	50	Type J small, red	93
608960	32	60	Type J small, yellow	93
609020	32	20	Type J blue	93
609025	32	25	Type J, light grey	93
609030	32	30	Type J, pink	93
609040	32	40	Type J, green	93
609050	32	50	Type J, red	93
609060	32	60	Type J, yellow	93
609545	32	45	Type E, red	96
609565	32	65	Type E, black	96
609575	32	75	Type E, grey	96
1014005	32	0,5	Glass fuses, 5x20 mm, quick	92
1014010	32	1	Glass fuses, 5x20 mm, quick	92
1014012	32	1,25	Glass fuses, 5x20 mm, quick	92
1014016	32	1,6	Glass fuses, 5x20 mm, quick	92
1014020	32	2	Glass fuses, 5x20 mm, quick	92
1014025	32	2,5	Glass fuses, 5x20 mm, quick	92

Type	V	A	i	P.
1014031	32	3,15	Glass fuses, 5x20 mm, quick	92
1014040	32	4	Glass fuses, 5x20 mm, quick	92
1014050	32	5	Glass fuses, 5x20 mm, quick	92
1014063	32	6,3	Glass fuses, 5x20 mm, quick	92
1014100	32	10	Glass fuses, 5x20 mm, quick	92
3148100	32	100	Big blade fuses, violet	86
6070100	32	100	Type C, blue	96
6070120	32	120	Type C, white	96
7048030	58	30	European bolt-on fuses, orange	90
7048040	58	40	European bolt-on fuses, green	90
7048050	58	50	European bolt-on fuses, red	90
7048060	58	60	European bolt-on fuses, yellow	90
7048070	58	70	European bolt-on fuses, brown	90
7048080	58	80	European bolt-on fuses, white	90
7048100	58	100	European bolt-on fuses, blue	90
7048125	58	125	European bolt-on fuses, pink	90
7048150	58	150	European bolt-on fuses, grey	90
7048175	58	175	European bolt-on fuses, light brown	90
7048200	58	200	European bolt-on fuses, violet	90
8048080	32	80	European bolt-on fuses, black	91
8048100	32	100	European bolt-on fuses, yellow	91
8048125	32	125	European bolt-on fuses, green	91



Product index

Fuses

Type	V	A	i	P.
8048150	32	150	European bolt-on fuses, orange	91
8048175	32	175	European bolt-on fuses, white	91
8048200	32	200	European bolt-on fuses, blue	91
8048225	32	225	European bolt-on fuses, light brown	91
8048250	32	250	European bolt-on fuses, pink	91
8048300	32	300	European bolt-on fuses, grey	91
8048350	32	350	European bolt-on fuses, dark green	91
8048400	32	400	European bolt-on fuses, violet	91
8048450	32	450	European bolt-on fuses, yellow ochre	91
8048500	32	500	European bolt-on fuses, brown	91
9048050	58	50	Compact fuses	98
9048075	58	75	Compact fuses	98
9048100	58	100	Compact fuses	98
9048125	58	125	Compact fuses	98
9048150	58	150	Compact fuses	98
9048175	58	175	Compact fuses	98
9048200	58	200	Compact fuses	98
9048250	58	250	Compact fuses	98
9048300	58	300	Compact fuses	98

Type	i	P.
1020	Fuse holder, blade terminals, made from bakelit	100
1110	Fuse holder with blade terminals and cap, connectable	100
1135	Fuse holder, crimp contacts and cap	100
2211	Fuse holder, crimp contacts, connectable to relay socket 2222	100
6302	Inline fuseholder for 5028xx micro II fuses, waterproof, with cable	99
6303	Fuse holder for 5018xx micro III fuses, with cable	99
6306	Fuse holder, inline fuse holder for plug-in fuses, waterproof, with cable	99
6307	Fuse holder, inline fuse holder for small plug-in fuses, waterproof, with cable	99
6308	Fuse holder, for jap. mini fuses	99
6309	Fuse holder, for small plug-in fuses	99
121400	Fuse holder, inline fuse holder	99
124800	Fuse holder, inline fuse holder for ceramic fuses, incl. 8A fuse	99
178200	Fuse holder, blade terminals, connectable	100
234600	Fuse box with 6 slots for plug-in fuses	102
234800	Fuse box with 8 slots for plug-in fuses	102
324800	Fuse holder, for 3248xx, screw connection	101
324822	Fuse holder, cover for 324800	101
324844	Fuse holder, fuseholder 324800 and cover 324822	101
372400	Fuse holder, for 4 Midi fuses with 200A max.	102
630501	Circuit+ Fuse holder, additional cicuit for micro II fuses with 10A max.	103
630601	Circuit+ Fuse holder, additional cicuit for regular blade fuses with 15A max.	103
630701	Circuit+ Fuse holder, additional cicuit for mini fuses with 15A max.	103



Product index

Fuse holders

Type	i	P.
630801	Circuit+ Fuse holder, additional circuit for mini low profile fuses with 10A max.	103
724800	Fuse holder, for 7048xxx	102
824800	Fuse holder, for 8048xxx	102

Type	V	A	i	P.
1142	12	25	Normally open micro relay	114
1143	12	25	Normally open micro relay	114
1162	12	15/25	Changeover micro relay	115
1163	12	15/25	Changeover micro relay, with diode	115
1164	12	15/25	Changeover micro relay, with resistance	115
1443	24	10	Normally open micro relay	114
1462	24	5/10	Changeover micro relay	115
1463	24	5/10	Changeover micro relay, with diode	115
1464	24	5/10	Changeover micro relay, with resistance	115
1465	24	10/15	Changeover micro relay, with resistance	115
2142	12	30	Normally open relay, 4 Pins	110
2143	12	30	Normally open relay, 4 Pins, with resistance	110
2144	12	40	Normally open relay, 4 Pins	110
2162	12	20/30	Changeover relay, with bracket	112
2242	12	30	Normally open relay, 4 Pins	110
2243	12	30	Normally open relay, 4 Pins, with fuse	110
2245	12	40	Normally open relay, 4 Pins, with resistance	110
2246	12	40	High power relay, with bracket, Audi VW type	113
2248	12	50	High power relay, with bracket	113
2252	12	30	Normally open relay, 5 Pins	111
2254	12	40	Normally open relay, 5 Pins	111
2262	12	20/30	Changeover relay, with bracket	112



Product index

Relays and flashers

Type	V	A	i	P.
2263	12	20/30	Changeover relay, with bracket, with resistance	112
2264	12	70/60	High power changeover, with bracket	114
2265	12	20/30	Changeover relay, with bracket, with diode	112
2268	12	30/40	Changeover relay, with bracket, high power	112
2270	12	70	High power relay, with bracket	113
2271	12	70	High power relay, with bracket, with diode	113
2274	24	40	High power relay, with bracket	113
2275	24	70	High power relay, with bracket, small housing	113
2276	24	70	High power relay, with bracket, with diode, small housing	113
4142	24	20	Normally open relay, 4 Pins	110
4143	24	20	Normally open relay, 4 Pins, with resistance	110
4162	24	10/20	Changeover relay, with bracket	112
4242	24	20	Normally open relay, 4 Pins	110
4243	24	20	Normally open relay, 4 Pins, with fuse	110
4252	24	20	Normally open relay, 5 Pins	110
4254	24	30	Normally open relay, 5 Pins	110
4262	24	10/20	Changeover relay, with bracket	112
4263	24	10/20	Changeover relay, with bracket, with resistance	112
4264	24	40/30	High power changeover, with bracket	114
4265	24	10/20	Changeover relay, with bracket, with diode	112
4268	24	20/30	Changeover relay, with bracket, high power	112
9242	12	200	Heavy Duty high power relay, big housing	113

Type	V	A	i	P.
9458	12	150	Smart battery relay	116
1620002	12		Flasher unit, 2 terminals, LED only, max. 30W	118
1620003	12		Flasher unit, 3 terminals, LED only, max. 30W	118
1621002	12		Flasher unit, 2 terminals, max. 300W	118
1621003	12		Flasher unit, 3 terminals, max. 300W	118
1622411	12		Flasher unit, 3 terminals, 2/4x21W, no bracket, small version	118
1622421	12		Flasher unit, 3 terminals, 2/4x21W	118
1622425	12		Flasher unit, 4 terminals, 2/4x21W, SAE standard	118
1628821	12/24		Flasher unit, 6 terminals	119
1632421	24		Flasher unit, 3 terminals, max. 170W	119
1634852	12/24		Flasher unit, 11 terminals, max. 170W, no control of flashing bulbs	119
1641002	24		Flasher unit, 2 terminals, max. 150W	119
1641003	24		Flasher unit, 3 terminals, max. 150W	119
1642421	24		Flasher unit, 3 terminals, 2/4x21W	119



Product index

Signal horns

Type	V	i	P.
63359	6	Disc horn, 91 mm diameter, 340Hz	122
123357	12	Disc horn, 70 mm diameter, 340Hz, 71,5x41x95 mm	122
123359	12	Disc horn, 91 mm diameter, 340Hz, 91x56x115 mm	122
124307	12	Disc horn, 70 mm diameter, 430Hz, 71,5x41x95 mm	122
124309	12	Disc horn, 91 mm diameter, 430Hz, 91x56x115 mm	122
127659	12	Disc horn, set of 123359 and 124309	122
128097	12-80	Back-up alarm, 97dB, contains additional relay	125
129206	12	Fanfare horn, set of one 410Hz and one 500Hz fanfare horn	123
243359	24	Disc horn, 91 mm diameter, 340Hz, 91x56x115 mm	122
244309	24	Disc horn, 91 mm diameter, 430Hz, 91x56x115 mm	122
247659	24	Disc horn, set of 123359 and 124309	123
249206	24	Fanfare horn, set of one 410Hz and one 500Hz fanfare horn	123
483359	48	Disc horn, 91 mm diameter, 340Hz, 91x56x115 mm	123
11690120	12	Ultra air horn, two tone air compressor horn, HIGH 660Hz, LOW 520Hz, ≥ 112 dB at 2m	124
11690122	12	Ultra air horn, two tone air compressor horn, HIGH 660Hz, LOW 520Hz, ≥ 112 dB at 2m, chrome finish	124
11690124	24	Ultra air horn, two tone air compressor horn, HIGH 660Hz, LOW 520Hz, ≥ 112 dB at 2m	124
11690220	24	Ultra air horn, low tone air compressor horn, 300Hz, ≥ 112 dB at 2m	125
11690240	24	Ultra air horn, low tone air compressor horn, 300Hz, ≥ 112 dB at 2m	125
11690320	12	Ultra air horn, two tone air compressor horn, HIGH 660Hz, LOW 520Hz, ≥ 112 dB at 2m, separate compressor	124

Type	V	i	P.
1122		Micro relay socket, no bracket	134
1123		Micro relay socket, with bracket	134
1444		Bulb holder, for H1	130
1445		Bulb holder, for H1	130
2222		Mini relay socket, for relays with 6,3 mm pins	134
2223		Mini relay socket, for high power relays	134
2224		Mini relay socket, for high power changeover relays	134
2444		Bulb holder, for bulbs with socket W3x16d, incl. cables	132
2644		Bulb holder, for bulbs with socket W3x16q, incl. cables	132
3444		Bulb holder, for bulbs with socket W2,5x16d, incl. cables	133
3644		Bulb holder, for bulbs with socket W2,5x16q, incl. cables	133
4041		Bulb holder, for bulbs with socket BA9s, incl. cables	133
4144		Bulb holder, for bulbs with socket W2x4,6d, incl. cables	133
4244		Bulb holder, for bulbs with socket W2,1x9,5d	133
4245		Bulb holder, for bulbs with socket W2,1x9,5d, incl. cables	133
4444		Bulb holder, for H4, requires 2,5 mm ² cables	130
4445		Bulb holder, for H4, incl. cables	130
4446		Bulbholder, ceramic, for high wattage H4, incl. cables	130
5444		Bulb holder, for bulbs with socket BAY15d, incl. cables	132
6444		Bulb holder, for bulbs with socket BA15s, incl. cables	132
6445		Bulb holder, for bulbs with socket BAU15s, incl. cables	132
7444		Bulb holder, for H7, incl. cables	130



Product index

Accessories

Type	V	i	P.
8004		Spare lamp kit, grey foam, H4 kit	135
8007		Spare lamp kit, grey foam, H7 kit	135
8017		Spare lamp kit, grey foam, H1 and H7 kit	135
8044		Spare lamp kit, grey foam, 24V H4 kit	136
8201		Spare lamp kit, yellow box, H1 kit	135
8204		Spare lamp kit, yellow box, H4 kit	135
8207		Spare lamp kit, yellow box, H7 kit	135
8405		Spare lamp kit, grey foam, double 24V H4 kit	136
8407		Spare lamp kit, grey foam, double 24V H7 kit	136
9440		Bulb holder, for 880, 893, and 890, incl. cables	131
9441		Bulb holder, for 881, 886, 894 and 896, incl. cables	131
9444		Bulb holder, for 9004 and 9007, incl. cables	131
9445		Bulb holder, for HB3, H10, H12 and HIR1, incl. cables	131
9446		Bulb holder, for HB4 and HIR2, incl. cables	131
9448		Bulb holder, for H8, H9 and H11, incl. cables	130
9449		Bulb holder, for H13/9008, incl. cables	131
14442		Bulb holder, for H1, incl. cables	130
16560		Fuse tester and puller	129
16552		Fuse puller for plug-in fuses	129
18810		Sales display, yellow, for standard bulbs	144
18812		Sales display, violet, for Ultra +90% bulbs	144
18900		Sales display, metal lamp cabinet	145

Type	V	i	P.
80200		Workshop kit, assorted small bulbs	137
112305		Micro relay socket, with pins	134
112310		Micro relay socket, with cable and pins	134
181399	12/24	Power adapter, with cover	128
181400	12	Power adapter, with cover and light	128
181403	12	Cigarette lighter, no light, big button	128
181404	12	Cigarette lighter, with light	128
181407	12	Cigarette lighter, with light, small button	128
181411	24	Cigarette lighter, with light	128
181412	24	Power adapter, with cover and light	128
181420	12/24	Universal plug, incl. 8A fuse, fits cigarette lighters and power adapters	129
181740	12/24	USB charger, 4800mA, 2 x USB-A, 1 x USB-C	128
183000	6-24	Bulb tester	129
183044	6-24	Voltager tester	129
213010		Fuse kit, small blade fuse kit	139
213020		Fuse kit, jap. miniature blade fuse kit	140
213040		Fuse kit, regular blade fuse kit	141
213050		Fuse kit, mixed blade fuse kit	138
213070		Fuse kit, mixed fuse kit	142
222205		Mini relay socket, for relays with 6,3 mm pins, incl. pins	134
222210		Mini relay socket, for relays with 6,3 mm pins, incl. cables and pins	134
222305		Mini relay socket, for high power relays, incl. pins	134



Product index

Accessories

Type	V	i	P.
222310		Mini relay socket, for high power relays, incl. cables and pins	134
222405		Mini relay socket, for high power changeover relays, incl. pins	134
222410		Mini relay socket, for high power changeover relays, incl. cables and pins	134