

BLAZER[®]

INTERNATIONAL



VEHICLE LIGHTING
PRODUCTS AND ACCESSORIES
AUTOMOTIVE • TRAILER • TRUCK • RECREATIONAL



About us

Blazer® International is a leading provider of DOT, SAE FMVSS108 and Canadian CMVSS 108 compliant and approved vehicular lighting products to the truck, trailer, marine and RV markets. Blazer® lighting products have built a strong reputation in the industry with over 50 years of quality, value and customer service.

The Blazer® brand is strategically positioned to meet the needs of OEM and automotive aftermarket customers across a wide range of lighting products. The Blazer® product line includes clearance markers, stop/tail/turn lights, trailer lights, fog and driving lights, warning and tractor/work lights, license, interior, back-up and utility lights, reflectors, replacement lenses, horns, flashers, replacement bulbs, brackets, grommets and plugs. LED and incandescent bulb options are available across the Blazer® line of lighting products. Innovative new products that include universal stop/tail/turn lights and wireless tow/trailer kits, along with packaging that allows the user to try the product at retail, rounds out the line of products within the Blazer® brand.

Blazer® International is headquartered in Long Grove, Illinois and is a part of the Tiger Accessory Group, a division of MAT Holdings, Incorporated.



TABLE OF CONTENTS

LED CLEARANCE MARKERS	6-13
LED STOP/TAIL/TURN	14-21
LED TRAILER LIGHT KITS	22-25
INCANDESCENT CLEARANCE MARKERS	26-35
INCANDESCENT STOP/TAIL/TURN	36-41
INCANDESCENT TRAILER LIGHT KITS	42-45
WARNING/EMERGENCY	46-49
FOG & DRIVING	50-55
OFF-ROAD LIGHTING & ACCESSORIES	56-65
TRACTOR/WORK	66-69
LICENSE/INTERIOR/BACK-UP/UTILITY	70-77
REFLECTORS	78-83
REPLACEMENT LENSES	84-87
BRACKETS/PLUGS/GROMMETS	88-91
TECHNICAL REFERENCE	92-101
NUMERICAL INDEX	102-106

Photometric Equipment

Our photometric and validation testing laboratory in Long Grove, Illinois ensures consistent quality and compliance with all of the necessary standards.



Computer controlled goniometer measures light brightness and illumination at the various angles required by US FMVSS 108 and CMVSS188.

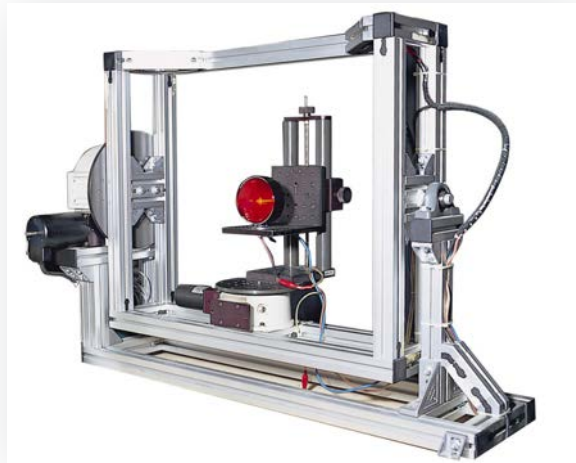

Testing Equipment

Temperature and Humidity Chamber

Ensures our lamps will continue to function under the most extreme weather conditions.



Vibration Testing Equipment

Simulates the rough conditions that lamps will go through when mounted on trucks and trailers. It tests to make sure that there is no evidence of material weakness, lens or reflector rotation, and/or displacement that could cause a product to function incorrectly.



Our Commitment to Quality

Testing Equipment

Dust Testing

Performed to confirm that light output will not be affected by road or weather conditions that cause excessive amounts of dust.



Rain Tester

Simulates rain, mist, and road spray, and is used to test for any moisture buildup inside of the light which could cause it to fail during use.



LED Testing Equipment

Is used during incoming inspection to guarantee that LED diodes meet requirements for light output before they are assembled into lighting products.



Salt Spray Tester

Testing is done to ensure that lighting products are corrosion resistant.



LED CLEARANCE MARKERS



Featuring the CW1586A / CW1586R

- DOT approved – Meets FMVSS108 and CMVSS 108 Safety Standards ensuring that you are receiving the safest of products
- Made with the latest LED technology, our clearance markers offer long lasting performance
 - Energy efficient – LEDs use 1/10th the amperage draw as incandescent bulbs
 - Durable and shock-proof – LEDs withstand road vibration and shaking
 - Maintenance-free – no bulb changes

PC2
HAYED
LIGHT

* LED 3/4" ROUND SIDE/CLEARANCE MARKER

- Hardwire design prevents lamp-plug failures and corrosion
- Can be used as ID lights (3 required), utility, step well or cabinet lights
- Easily installs into any 3/4" opening
- Current draw: 0.02 Amps

SKU	DESCRIPTION	COLOR	DIODES	CASE QTY
B534A2	Display Pack - "Try Me" 2 Pk light with chrome flange	amber	1	6
B534R2	Display Pack - "Try Me" 2 Pk light with chrome flange	red	1	6
C1534BAK	Display Pack - Blister pack light with grommet	amber	1	24
C1534BRK	Display Pack - Blister pack light with grommet	red	1	24
C2534BAK	Display Pack - Blister pack 2 Pk light with grommets	amber	1	12
C2534BRK	Display Pack - Blister pack 2 Pk light with grommets	red	1	12
C534BAK	Display Pack - Polybag light with grommet	amber	1	36
C534BRK	Display Pack - Polybag light with grommet	red	1	36
C534AK6	Display Pack - Polybag 6 Pk lights with 6 grommets and 6 chrome flanges	amber	1	12
C534RK6	Display Pack - Polybag 6 Pk lights with 6 grommets and 6 chrome flanges	red	1	12
534CBAK	Light with grommet, clear lens	amber	1	400
534CBRK	Light with grommet, clear lens	red	1	400
534BAK	Light with grommet	amber	1	400
534BRK	Light with grommet	red	1	400
534CAK	Light with chrome flange	amber	1	400
534CRK	Light with chrome flange	red	1	400
534BAK2B	light with grommet	amber	1	400
534BRK2B	light with grommet	red	1	400

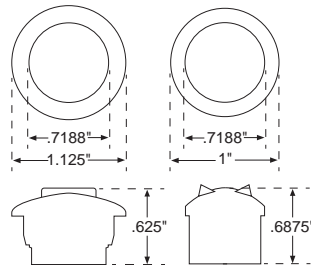

LED 3/4" FENDER MOUNT SIDE/CLEARANCE LIGHT

- Engineering grade plastic for long lasting durability
- 8" lead wires
- Current draw: 0.05 Amps

SKU	DESCRIPTION	COLOR	DIODES	CASE QTY
B9534AR2	Display Pack - left hand side and right hand side light	amber/ red	2	6
98534AR	left hand side light	amber/ red	2	150
99534AR	right hand side light	amber/ red	2	150
98534CAR	left hand side light w/ clear lens	amber/ red	2	150
99534CAR	right hand side light w/ clear lens	amber/ red	2	150

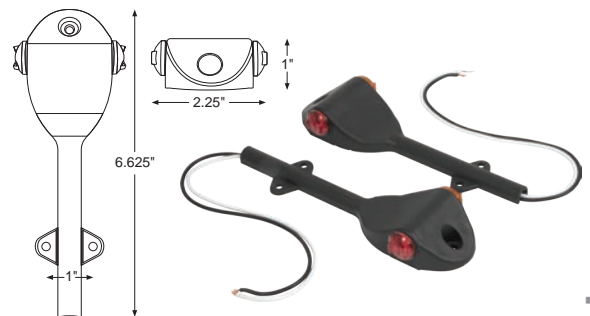

*See page #93 for details

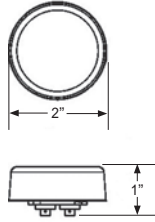

LED 2" ROUND SIDE/CLEARANCE MARKER

- Housing and lens are sonic welded to create a sealed light
- Electronics are sealed in epoxy to resist corrosion and moisture
- Accepts industry standard 2-prong plug
- Current draw: 0.05 Amps

SKU	DESCRIPTION	COLOR	DIODES	CASE QTY
C525A	Display Pack - light, grommet and plug	amber	1	24
C525R	Display Pack - light, grommet and plug	red	1	24

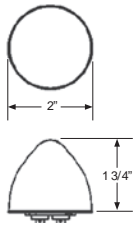

LED 2" BEEHIVE SIDE/CLEARANCE MARKER

- Housing and lens are sonic welded to create a sealed light
- Electronics are sealed in epoxy to resist corrosion and moisture
- Accepts industry standard 2-prong plug
- Current draw: 0.05 Amps

SKU	DESCRIPTION	COLOR	DIODES	CASE QTY
505BAK	light, grommet and plug	amber	8	200
505BRK	light, grommet and plug	red	8	200
93875	plug only	-	-	500

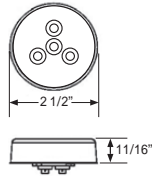

LED 2 1/2" ROUND SIDE/CLEARANCE MARKER

- Housing and lens are sonic welded to create a sealed light
- Electronics are sealed in epoxy to resist corrosion and moisture
- Accepts industry standard 2-prong plug
- Current draw: 0.05 Amps

SKU	DESCRIPTION	COLOR	DIODES	CASE QTY
504BA	light only	amber	4	200
504BR	light only	red	3	200
95206-1	grommet only	-	-	200
93875	plug only	-	-	500



* LED 2" ROUND SIDE/CLEARANCE MARKER

- Housing and lens are sonic welded to create a sealed light
- Electronics are sealed in epoxy to resist corrosion and moisture
- Accepts industry standard 2-prong plug
- Current draw: 0.05 Amps

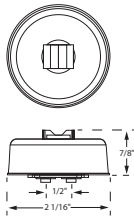

SKU	DESCRIPTION	COLOR	DIODES	CASE QTY
507BAK	light, grommet and plug	amber	5	200
507BRK	light, grommet and plug	red	5	200
507BA	light only	amber	5	200
507BR	light only	red	5	200

LED 2" ROUND SIDE/CLEARANCE MARKER

- Housing and lens are sonic welded to create a sealed light
- Electronics are sealed in epoxy to resist corrosion and moisture
- Accepts industry standard 2-prong plug
- Current draw: 0.05 Amps

SKU	DESCRIPTION	COLOR	DIODES	CASE QTY
533BAK	light, grommet and plug	amber	4	200
533BRK	light, grommet and plug	red	4	200
533BA	light only	amber	4	200
533BR	light only	red	4	200

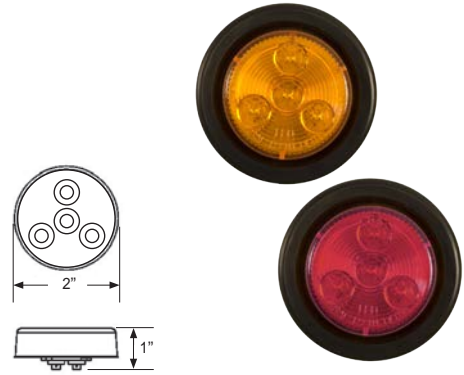

LED 2" ROUND SIDE/CLEARANCE MARKER

- Housing and lens are sonic welded to create a sealed light
- Electronics are sealed in epoxy to resist corrosion and moisture
- Accepts industry standard 2-prong plug
- Current draw: 0.05 Amps

SKU	DESCRIPTION	COLOR	DIODES	CASE QTY
506BAK	light, grommet and plug	amber	1	240
506BRK	light, grommet and plug	red	1	240
506BA	light only	amber	1	400
506BR	light only	red	1	400
93875	plug only	-	-	500

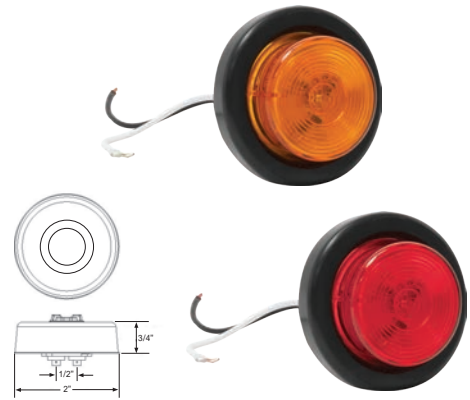

LED 2 1/2" ROUND SIDE/CLEARANCE MARKER

- Housing and lens are sonic welded to create a sealed light
- Electronics are sealed in epoxy to resist corrosion and moisture
- Accepts industry standard 2-prong plug
- Current draw: 0.05 Amps

SKU	DESCRIPTION	COLOR	DIODES	CASE QTY
C526A	Display Pack - light, grommet and plug	amber	1	24
C526R	Display Pack - light, grommet and plug	red	1	24



* LED 2 1/2" ROUND SIDE/CLEARANCE MARKER

- Housing and lens are sonic welded to create a sealed light
- Electronics are sealed in epoxy to resist corrosion and moisture
- Accepts industry standard 2-prong plug
- Current draw: 0.05 Amps

SKU	DESCRIPTION	COLOR	DIODES	CASE QTY
508BA	light only	amber	7	200
508BR	light only	red	7	200

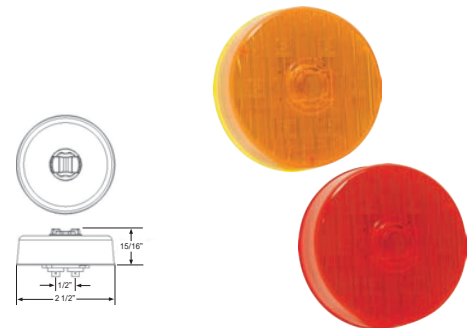

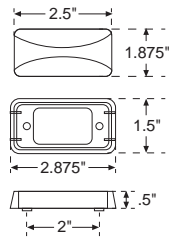

LED 2 1/2" RECTANGULAR SIDE/CLEARANCE MARKER

- Kit comes with bracket, gasket, bullet connector and mounting screws
- Electronics are sealed in epoxy to resist corrosion and moisture
- Current draw: 0.05 Amps

SKU	DESCRIPTION	COLOR	DIODES	CASE QTY
CW1536A	Display Pack - light, chrome bracket and plug	amber	1	24
CW1536R	Display Pack - light, chrome bracket and plug	red	1	24
536BAKB	light, black bracket and plug	amber	1	200
536BRKB	light, black bracket and plug	red	1	200
536BA	light only	amber	1	200
536BR	light only	red	3	200
93875	plug only	-	-	500

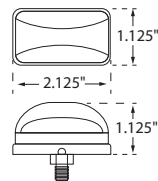

LED 2 1/8" RECTANGULAR SIDE/CLEARANCE MARKER

- Housing and lens are sonic welded to create a sealed light
- Stud mount installation
- Single wire design
- Current draw: 0.05 Amps

SKU	DESCRIPTION	COLOR	DIODES	CASE QTY
C588A	Display Pack - light only	amber	3	24
C588R	Display Pack - light only	red	3	24
588BA	light only	amber	3	200
588BR	light only	red	3	200

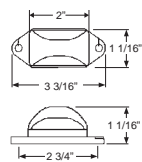

LED 3 3/16" RECTANGULAR SIDE/CLEARANCE MARKER

- Housing and lens are sonic welded to create a sealed light
- Surface mounts with ear mount base
- Current draw: 0.05 Amps

SKU	DESCRIPTION	COLOR	DIODES	CASE QTY
CW1586A	Display Pack - light only	amber	2	24
CW1586R	Display Pack - light only	red	2	24

LED 2 7/8" RECTANGULAR SIDE/CLEARANCE MARKER WITH REFLEX

- Stud mount installation
- Two-wire design
- Replaceable lens
- Current draw: 0.02 Amps

SKU	DESCRIPTION	COLOR	DIODES	CASE QTY
CW523A	Display Pack - light only	amber	1	24
C523R	Display Pack - light only	red	1	24
523BA	light only	amber	1	200
C595A	Display Pack - ear mount	amber	1	12

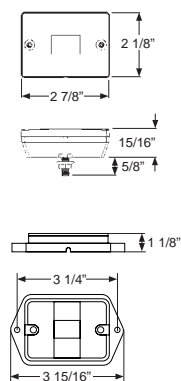

LED 4" OBLONG SIDE/CLEARANCE MARKER

- Surface mount installation
- Single wire design
- Current draw: 0.05 Amps

SKU	DESCRIPTION	COLOR	DIODES	CASE QTY
CW1544A	Display Pack - light with grommet	amber	2	24
CW1544R	Display Pack - light with grommet	red	2	24

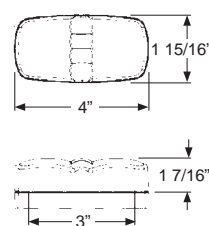

LED 4" DOUBLE BULLSEYE SIDE/CLEARANCE MARKER

- Surface mount installation
- Two-wire design
- Current draw: 0.05 Amps

SKU	DESCRIPTION	COLOR	DIODES	CASE QTY
C539A	Display Pack - light only	amber	2	24
C539R	Display Pack - light only	red	2	24
539BA	light only	amber	2	200
539BR	light only	red	2	200

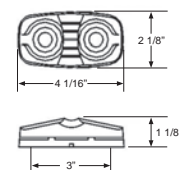

LED 6 5/8" OBLONG SIDE/CLEARANCE MARKER

- Surface mount installation
- Electronics are sealed in epoxy to resist corrosion and moisture
- Two-wire design
- Current draw: 0.05 Amps

SKU	DESCRIPTION	COLOR	DIODES	CASE QTY
C323WBAK	Display Pack - light with chrome bezel	amber	4	12
C323WBRK	Display Pack - light with chrome bezel	red	4	12
323WBA	light only	amber	4	200
323WBR	light only	red	4	200

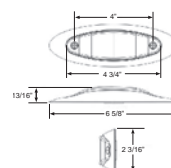

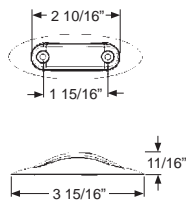

LED 2 5/8" OBLONG SIDE/CLEARANCE MARKER

- Surface mount installation
- Electronics are sealed in epoxy to resist corrosion and moisture
- Two-wire design
- Current draw: 0.05 Amps

SKU	DESCRIPTION	COLOR	DIODES	CASE QTY
C3221A	Display Pack - light only	amber	2	24
C3221R	Display Pack - light only	red	2	24
C322A	Display Pack - light with chrome bezel	amber	2	24
C322R	Display Pack - light with chrome bezel	red	2	24
322BAK	light with chrome bezel	amber	2	200
322BRK	light with chrome bezel	red	2	200
322BA	light only	amber	2	200
322BR	light only	red	2	200

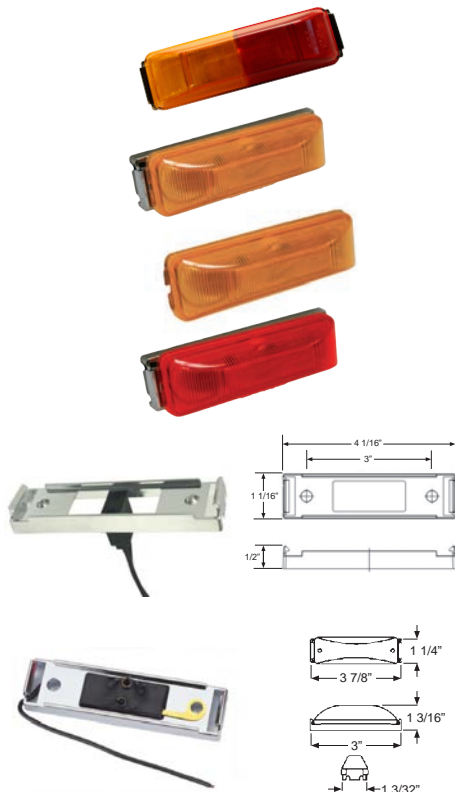

LED 4" RECTANGULAR RUNNING BOARD LIGHT

- Housing and lens are sonic welded to create a sealed light
- Electronics are sealed in epoxy to resist corrosion and moisture
- Surface mount installation
- Current draw: 0.03 Amps

SKU	DESCRIPTION	COLOR	DIODES	CASE QTY
CW1531A	Display Pack - light, chrome bracket and plug	amber	6	24
CW1531R	Display Pack - light, chrome bracket and plug	red	6	24
531BARK	light only	amber/red	6	200
531AK	light, chrome bracket and plug	amber	6	200
531RK	light, chrome bracket and plug	red	6	200
531BAK	light, black bracket and plug	amber	6	200
531BRK	light, black bracket and plug	red	6	200
531AR	light only	amber/red	6	200
92232C	mounting bracket - chrome	-	-	500
92232B	mounting bracket - black	-	-	500
92232CK	mounting kit - chrome bracket and plug	-	-	500
92232BK	mounting kit - black bracket and plug	-	-	500

LED 4" RECTANGULAR SIDE/CLEARANCE MARKER

- Also functions as identification light
- Surface mount installation
- Two-wire design
- Current draw: 0.02 Amps

SKU	DESCRIPTION	COLOR	DIODES	CASE QTY
C535A	Display Pack - light with grommet	amber	2	24
C535R	Display Pack - light with grommet	red	2	24

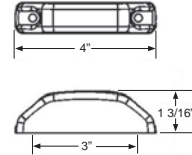

LED LOW-PROFILE SUBMERSIBLE IDENTIFICATION LIGHT BAR

- Surface mount installation
- Electronics are sealed in epoxy to resist corrosion and moisture
- Two-wire design
- Current draw: 0.14 Amps

SKU	DESCRIPTION	COLOR	DIODES	CASE QTY
C513R	Display Pack - ID light bar	red	3	8
513BR	ID light bar only	red	3	50

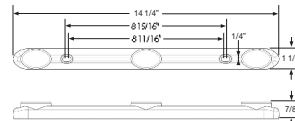

LED SUBMERSIBLE IDENTIFICATION LIGHT BAR

- Surface mount installation with stainless steel frame
- Housing and lens are sonic welded to create a sealed light
- Features 15" lead wire
- Current draw: 0.2 Amps

SKU	DESCRIPTION	COLOR	DIODES	CASE QTY
C514RW	Display Pack - ID light bar	red	9	8
514BR	ID light bar only	red	9	50

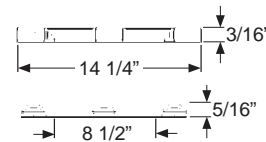

LED LOW-PROFILE IDENTIFICATION LIGHT BAR - P2

- Surface mount installation
- Electronics are sealed in epoxy to resist corrosion and moisture
- Two-wire design
- Current draw: 0.3 Amps

SKU	DESCRIPTION	COLOR	DIODES	CASE QTY
C3490R	Display Pack - ID light bar - P2	red	3	24
3490RC	ID light bar with chrome bezel - P2	red	3	50
3490R	ID light bar - P2	red	3	50

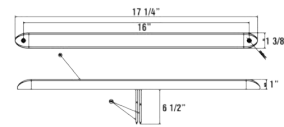

LED STOP/TAIL/TURN



Featuring the C563RTM

- DOT approved – Meets FMVSS108 and CMVSS 108 Safety Standards ensuring that you are using approved lighting
- Made with the latest LED technology, our clearance markers offer long lasting performance
 - Energy efficient – LEDs use 1/10th the amperage draw as incandescent bulbs
 - Durable and shock-proof – LEDs withstand road vibration and shaking
 - Maintenance-free – no bulb changes

LED LOW-PROFILE STOP/TAIL/TURN LIGHT BAR WITH CHROME COLOR BEZEL - OVER 80"

- Surface mount installation
- Housing and lens are sonic welded to create a sealed light
- Three-wire design
- Current draw: 0.2 Amps

SKU	DESCRIPTION	COLOR	DIODES	CASE QTY
C3491RC	Display Pack - stop, tail, turn light only	red	9	24
3491RC	stop, tail, turn light with chrome bezel	red	9	50
3491R	light only stop, turn	red	9	50
3491CR	light only stop, turn - clear lens	*red	9	50

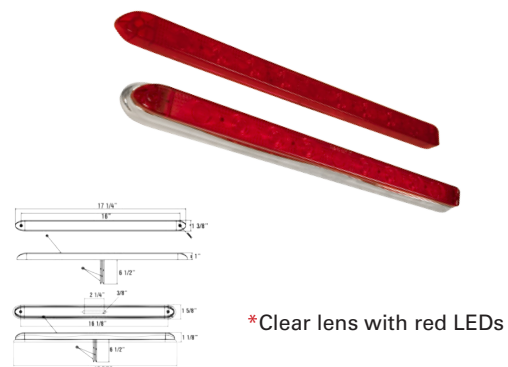

LED 6" OVAL STOP/TAIL/TURN LIGHT AND PARK/TURN SIGNAL WITH CHROME BEZEL

- Surface mount installation - chrome bezel snaps onto black flange
- Housing and lens are sonic welded to create a sealed light
- Three-wire design
- Current draw: 0.2 Amps

SKU	DESCRIPTION	COLOR	DIODES	CASE QTY
C563RTM	Display Pack - "Try Me" light wth chrome bezel	red	10	12
563BAK	light wth chrome bezel	amber	10	10
563BRK	light wth chrome bezel	red	10	10
563BR	light only	red	10	10
97563	bezel only - chrome	-	-	20



LED 6" OVAL SURFACE MOUNT STOP/TAIL/TURN AND PARK/TURN LIGHTS

- Surface mount installation
- Housing and lens are sonic welded to create a sealed light
- Three-wire design
- Current draw: 0.2 Amps

SKU	DESCRIPTION	COLOR	DIODES	CASE QTY
C562ATM	Display Pack - "Try Me" light only	amber	10	12
C562RTM	Display Pack - "Try Me" light only	red	10	12

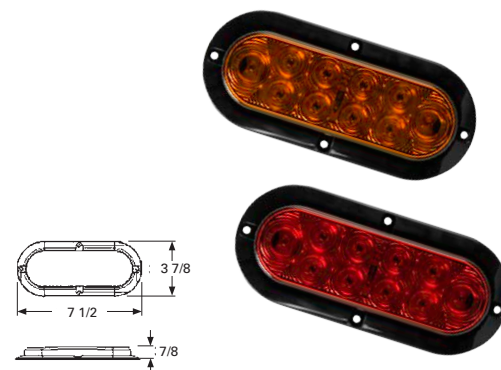



LED 6" OVAL GROMMET MOUNT STOP/TAILO/TURN AND PARK/TURN LIGHTS

- Grommet mount installation
- Housing and lens are sonic welded to create a sealed light
- Accepts industry standard 3-prong plug
- Current draw: 0.2 Amps

SKU	DESCRIPTION	COLOR	DIODES	CASE QTY
C561ATM	Display Pack - "Try Me" light and grommet	amber	6	12
C561RTM	Display Pack - "Try Me" light and grommet	red	6	12
C561RL	Display Pack - "Try Me" light only	red	6	12
C562CATM	Display Pack - "Try Me" light, grommet and plug	clear/amber	10	12
C562CRTM	Display Pack - "Try Me" light, grommet and plug	clear/red	10	12
562BCR	light only - clear lens	red	10	60
561BRK	light, grommet and plug	red	10	60
561BR	light only	red	10	120
561BA	light only - park / turn signal	amber	10	50
565BRK	light and grommet - wire lead	red	10	50
565BR	light only - wire lead	red	10	50
95233	grommet only	-	-	100
93876	plug only	-	-	500

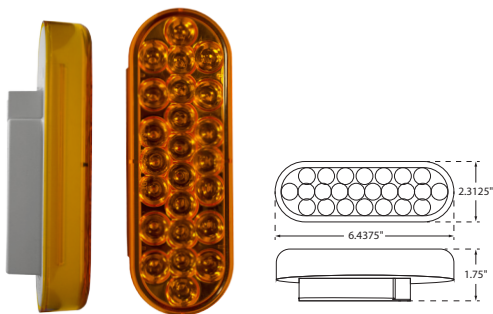

LED 6" OVAL STROBE LIGHT

- Grommet mount installation
- Alternating (wig-wag) or synchronous strobe pattern
- Ideal for emergency vehicles, construction equipment, work trucks and any vehicle needing greater visibility
- Current draw: 0.45 Amps

SKU	DESCRIPTION	COLOR	DIODES	CASE QTY
5641B	light only, wig	amber	34	60
5642B	light only, wag	amber	34	60

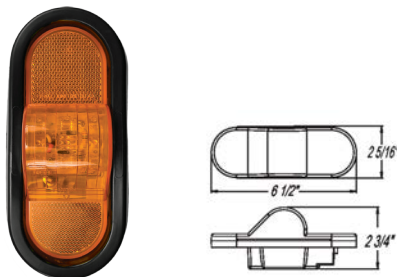

LED 6" OVAL MIDTURN SIGNAL LIGHT

- Grommet mount installation
- Housing and lens are sonic welded to create a sealed light
- Accepts industry standard 3-prong plug
- Current draw: 0.25 Amps

SKU	DESCRIPTION	COLOR	DIODES	CASE QTY
529BA	light only	amber	9	50
529BAK	light, grommet and plug	amber	9	50

LED 4" ROUND STROBE LIGHT

- Grommet mount installation
- Alternating (wig-wag) or synchronous strobe pattern
- Ideal for emergency vehicles, construction equipment, work trucks and any vehicle needing greater visibility
- Current draw: 0.45 Amps

SKU	DESCRIPTION	COLOR	DIODES	CASE QTY
5441B	light only, wig	amber	24	60
5442B	light only, wag	amber	24	60

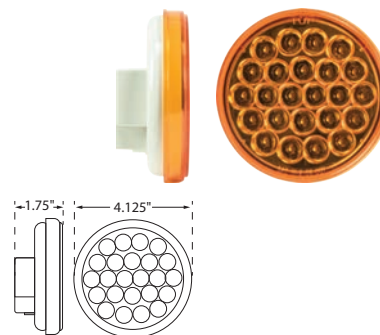

LED 4" ROUND PARK AND STOP/TAIL/TURN LIGHT

- Grommet mount installation
- Housing and lens are sonic welded to create a sealed light
- Accepts industry standard 3-prong plug
- Current draw: 0.2 Amps

SKU	DESCRIPTION	COLOR	DIODES	CASE QTY
C542RTM	Display Pack - "Try Me" light, grommet and plug	red	6	12
C542RL	Display Pack - "Try Me" light only	red	6	12
542BRK	light, grommet and plug	red	10	50
542BR	light only	red	10	50
546BR	light only - waterproof	red	10	50
553BR	light only - wire lead	red	7	50
B95227	Display Pack - grommet only	-	-	24
93876	plug only	-	-	500
93549	plug only - waterproof	-	-	500

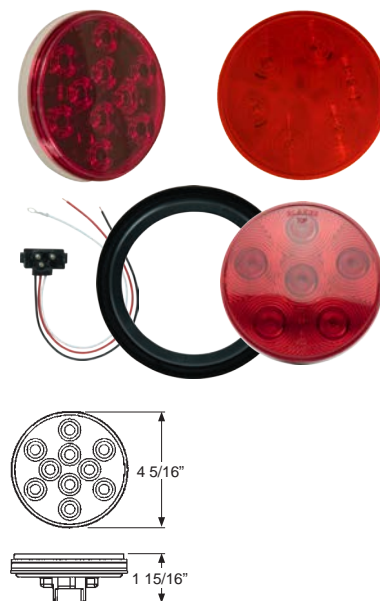

LED 4" ROUND STOP/TAIL/TURN LIGHT

- Flange mount installation
- Housing and lens are sonic welded to create a sealed light
- Accepts industry standard 3-prong plug
- Current draw: 0.2 Amps

SKU	DESCRIPTION	COLOR	DIODES	CASE QTY
C545RTM	Display Pack - "Try Me" light, grommet and plug	red	10	12
545BR	light only	red	10	50

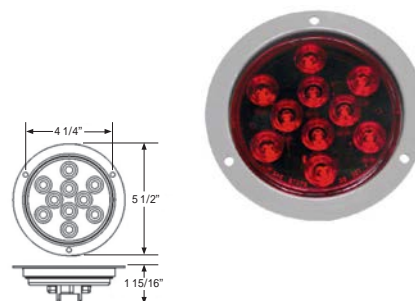

LED 7" ROUND BUS SIGNAL LIGHT WITH REFLEX

- Surface mount installation - mounting pad included for air tight seal
- Housing and lens are sonic welded to create a sealed light
- Three-wire design
- Current draw: 0.25 Amps

SKU	DESCRIPTION	COLOR	DIODES	CASE QTY
710BA	light only	amber	31	30
710BR	light only	red	31	30

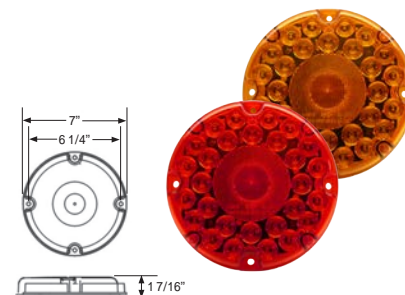

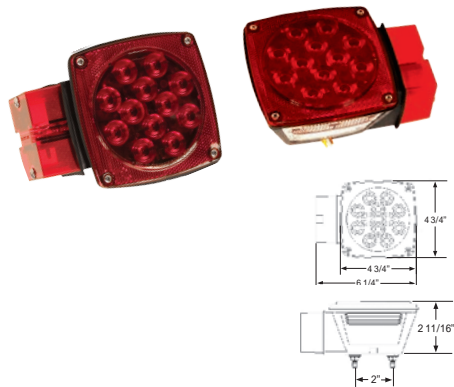

LED MULTI-REFLECTIVE COMBINATION STOP/TAIL/TURN LIGHT - OVER 80"

- 784B serves 8 functions: Stop, Turn, Tail, Rear Clearance, Rear Reflex, Side Marker, Side Reflex, and License Plate Illuminator
- 794B serves 7 functions: Stop, Turn, Tail, Rear Clearance, Rear Reflex, Side Marker and Side Reflex
- Stud mount installation
- Electronics are sealed in epoxy to resist corrosion and moisture
- Current draw: 0.4 Amps

SKU	DESCRIPTION	COLOR	DIODES	CASE QTY
784B	left hand side light only	red	23	50
794B	right hand side light only	red	18	50



LED SUBMERSIBLE COMBINATION STOP/TAIL/TURN LIGHT - UNDER 80"

- C7483RTM (C7423 left side replacement) serves 7 functions: Stop, Turn, Tail, Rear Clearance, Rear Reflex, Side Marker and License Plate Illuminator
- C7493RTM (C7423 right side replacement) serves 6 functions: Stop, Turn, Tail, Rear Clearance, Rear Reflex and Side Marker
- Side or back mounting options
- Electronics are sealed in epoxy to resist corrosion and moisture
- Current draw: 0.4 Amps

SKU	DESCRIPTION	COLOR	DIODES	CASE QTY
C7483RTM	Display Pack - "Try Me" left hand side light only	red	9	24
C7493RTM	Display Pack - "Try Me" right hand side light only	red	7	24

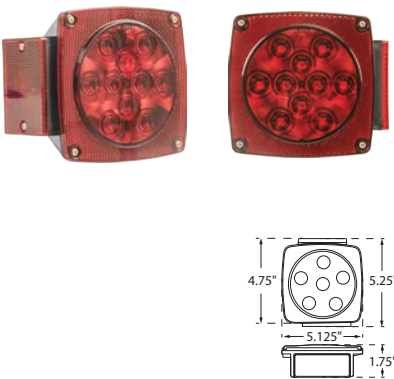

LED SUBMERSIBLE COMBINATION STOP/TURN/TAI LIGHT - UNDER 80"

- 783B serves 7 functions: Stop, Turn, Tail, Rear Clearance, Rear Reflex, Side Marker and License Plate Illuminator
- 793B serves 6 functions: Stop, Turn, Tail, Rear Clearance, Rear Reflex and Side Marker
- Stud mount installation
- Electronics are sealed in epoxy to resist corrosion and moisture
- Current draw: 0.19 Amps

SKU	DESCRIPTION	COLOR	DIODES	CASE QTY
783B	left hand side light only	red	21	50
793B	right hand side light only	red	16	50

LED UNIVERSAL COMBINATION STOP/TAIL/TURN LIGHT - UNDER 80" U.S. PATENT # 8,827,518

- 7 function left or right hand side replacement light: Stop, Turn, Tail, Rear Clearance, Rear Reflex, Side Marker and License Plate Illuminator
- Interchangeable side marker mounts on the left or right side of the light
- Housing and lens are sonic welded to create a sealed light
- Current draw: 0.5 Amps

SKU	DESCRIPTION	COLOR	DIODES	CASE QTY
C789RTM	Display Pack - "Try Me" left or right hand side light	red	11	12

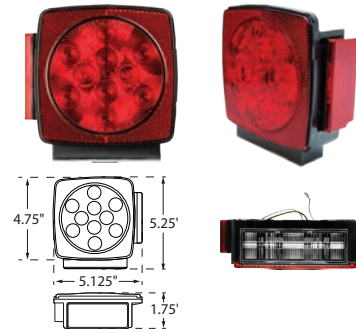

LEFTHAND - OR - RIGHTHAND

LED LOW-PROFILE SUBMERSIBLE STOP/TAIL/TURN LIGHT - OVER AND UNDER 80"

- C7288TM (C7280 left side replacement) serves 7 functions: Stop, Turn, Tail, Rear Clearance, Rear Reflex, Side Marker and License Plate Illuminator
- C7298TM (C7280 right side replacement) serves 6 functions: Stop, Turn, Tail, Rear Clearance, Rear Reflex and Side Marker
- Electronics are sealed in epoxy to resist corrosion and moisture
- Surface mounts on 2" or 4" mounting centers
- Current draw: 0.5 Amps

SKU	DESCRIPTION	COLOR	DIODES	CASE QTY
C7288TM	Display Pack - "Try Me" left hand side light only	red	10	24
C7298TM	Display Pack - "Try Me" right hand side light only	red	8	24
7288B	left hand side light only	red	22	24
7298B	right hand side light only	red	18	24

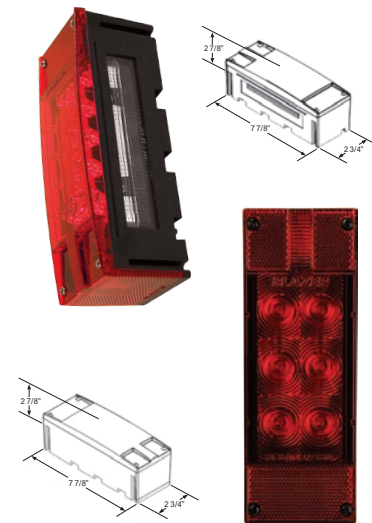

LED UNIVERSAL COMBINATION STOP/TAIL/TURN LIGHT WITH REVERSE AND LICENSE PLATE LIGHT

- 6 function: Stop, Turn, Tail, Rear Clearance, Rear Reflector, License Plate Illuminator and Back Up left or right hand side replacement light
- 4-wire design
- Electronics are sealed in epoxy to resist corrosion and moisture
- 3-stud mount installation on 2" centers
- Current draw: 0.9 Amps

SKU	DESCRIPTION	COLOR	DIODES	CASE QTY
C599SWTM	Display Pack - "Try Me" light	amber	36	24





CLASSIC LOOK with LED FEATURES & PERFORMANCE

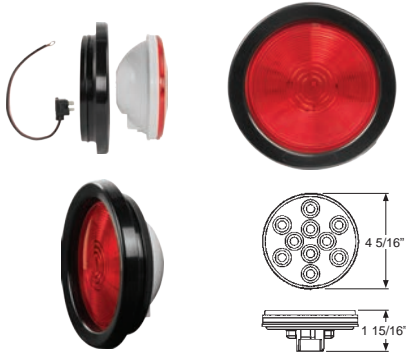

LED POWER1™ 4" ROUND STOP/TAIL/TURN LIGHT

- Grommet mount installation
- Housing and lens are sonic welded to create a sealed light
- Accepts industry standard 3-prong plug
- Electronics are sealed in epoxy to resist corrosion and moisture
- Current draw: 0.2 Amps

SKU	DESCRIPTION	COLOR	DIODES	CASE QTY
C542PTM	Display Pack - "Try Me" light, grommet and plug	red	1	12



LED POWER1™ 6" OVAL STOP/TAIL/TURN LIGHT

- Grommet mount installation
- Housing and lens are sonic welded to create a sealed light
- Accepts industry standard 3-prong plug
- Electronics are sealed in epoxy to resist corrosion and moisture
- Current draw: 0.2 Amps

SKU	DESCRIPTION	COLOR	DIODES	CASE QTY
C561PTM	Display Pack - "Try Me" light, grommet and plug	red	1	12



LED POWER1™ SUBMERSIBLE COMBINATION STOP/TAIL/TURN LIGHT - UNDER 80"

- C83PTM serves 7 functions: Stop, Turn, Tail, Rear Clearance, Rear Reflex, Side Marker and License Plate Illuminator
- C93PTM serves 6 functions: Stop, Turn, Tail, Rear Clearance, Rear Reflex and Side Marker
- Stud mount installation
- Electronics are sealed in epoxy to resist corrosion and moisture
- Current draw: 0.26 Amps

SKU	DESCRIPTION	COLOR	DIODES	CASE QTY
C83PTM	Display Pack - "Try Me" left hand side light only	red	4	12
C93PTM	Display Pack - "Try Me" right hand side light only	red	2	12
C8393PTM	Display Pack - "Try Me" left/right hand side lights only	red	4 left/ 2 right	12

LED TRAILER LIGHT KITS



Featuring the C7425

- DOT approved – Meets FMVSS108 and CMVSS 108 Safety Standards ensuring that you are using approved lighting
- All Blazer® LED trailer light kits come with necessary wiring, brackets, mounting hardware and instructions to install your lights

LED SUBMERSIBLE COMBINATION TRAILER LIGHT KIT - UNDER 80"

- Kit includes 2 S/T/T lights, 20' wiring harness with 4-flat connector, corrosion resistant license plate bracket, mounting hardware and instructions
- Side or back mounting options
- Electronics are sealed in epoxy to resist corrosion, moisture and vibration
- Current draw: 0.4 Amps /side

SKU	DESCRIPTION	COLOR	DIODES		CASE QTY
			Left	Right	
C7423	Display Pack - "Try Me" trailer light kit	red	9	7	8



LED SUBMERSIBLE TRAILER LIGHT KIT WITH INTEGRATED BACK-UP LIGHTS - UNDER 80"

- Kit includes 2 S/T/T lights, 20' wiring harness with 5-flat connector, corrosion resistant license plate bracket, mounting hardware and instructions
- Back-up function gives you 350 lumens of light - providing illumination to more accurately back, launch boats or garage trailers
- Housing and lens are sonic welded to create a sealed light and electronics are sealed in epoxy to resist corrosion and moisture
- 7-blade to 5-way flat adapter needed for installation
- Current draw: 0.6 Amps

SKU	DESCRIPTION	COLOR	DIODES		CASE QTY
			Left	Right	
C7425	Display Pack - "Try Me" trailer light kit	red/white	13	11	8



LED SUBMERSIBLE COMBINATION TRAILER LIGHT KIT - UNDER 80", CLEAR LENS

- Kit includes 2 S/T/T lights, 20' wiring harness with 4-flat connector, corrosion resistant license plate bracket, mounting hardware and instructions
- Stud mount installation
- Electronics are sealed in epoxy to resist corrosion, moisture and vibration
- Current draw: 0.4 Amps /side

SKU	DESCRIPTION	COLOR	DIODES		CASE QTY
			Left	Right	
C5721	Display Pack - trailer light kit	clear	21	16	8



LED LOW-PROFILE SUBMERSIBLE TRAILER LIGHT KIT - OVER AND UNDER 80"

- Kit includes 2 S/T/T lights, 20' wiring harness with 4-flat connector, corrosion resistant license plate bracket, mounting hardware and instructions
- Surface mounting on 2" or 4" mounting center
- Electronics are sealed in epoxy to resist corrosion, moisture and vibration
- Current draw: 0.4 Amps /side

SKU	DESCRIPTION	COLOR	DIODES		CASE QTY
			Left	Right	
C7280	Display Pack - trailer light kit	red	10	8	8





LED TOW LIGHT KIT

- Kit includes 2 towing lights, 20' wiring harness with 4-way connector
- Provides DOT compliant stop, turn and tail functions for your trailer or towed vehicle
- Tough polycarbonate base and lens and non-scratch heavy duty magnetic base for secure mount
- Current draw: Tail 0.26 Amps, Stop 0.51 Amps

SKU	DESCRIPTION	COLOR	DIODES		CASE QTY
			Left	Right	
C7300	Display Pack - tow light kit	red	12	12	10



LED WIRELESS TOW LIGHT KIT U.S. PATENT # 9,272,663 B2

- Kit includes 2 S/T/T lights, 20' wiring harness with 4-flat connector, corrosion resistant license plate bracket, mounting hardware and instructions
- Provides over 65' of wireless operation and DOT compliant stop, turn and tail functions for your trailer or towed vehicle
- Tough polycarbonate base and lens and non-scratch heavy-duty magnetic base for secure mount - resin tie-downs to help secure lights
- 4AA alkaline batteries required per light (not included)

SKU	DESCRIPTION	COLOR	DIODES		CASE QTY
			Left	Right	
C6304	Display Pack - tow light kit	red	10	10	4



LED POWER1™ SUBMERSIBLE TRAILER LIGHT KIT - UNDER 80"

- Kit includes 2 S/T/T lights, 20' wiring harness with 4-flat connector, corrosion resistant license plate bracket, mounting hardware and instructions
- Stud mount installation
- Electronics are sealed in plastic casing inside of the housing
- Current draw: 0.26 Amps

SKU	DESCRIPTION	COLOR	DIODES		CASE QTY
			Left	Right	
C6423PTM	Display Pack - "Try Me" trailer light kit	red	4	2	12

INCANDESCENT CLEARANCE MARKERS



Featuring the B485A

- DOT approved – Meets FMVSS108 and CMVSS 108 Safety Standards ensuring that you are using approved lighting
- Durable housing and lens protect against corrosion
- Retail and OEM configurations available

INCANDESCENT CLEARANCE MARKERS

2 13/16" ROUND SIDE/CLEARANCE MARKER

- Surface mount installation
- Acrylic lens snaps onto ABS housing
- Single-wire design grounds through the mounting hardware
- Current draw: 0.35 Amps

SKU	DESCRIPTION	COLOR	CASE QTY
B827A	Display Pack - light only	amber	72
B827R	Display Pack - light only	red	72
9827A	lens only	amber	500
9827R	lens only	red	500

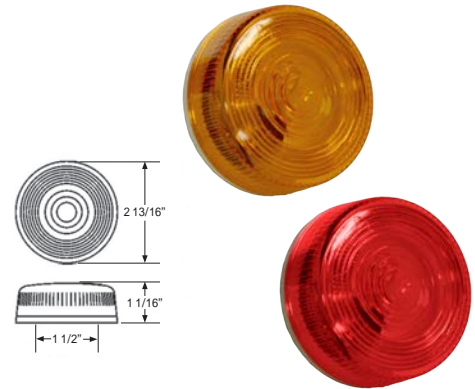

PC2 RATED LIGHT * 2 1/2" ROUND SIDE/CLEARANCE MARKER

- Grommet mount installation
- Sealed light - Acrylic lens and ABS housing are sonic welded
- Accepts industry standard 2-prong plug
- Current draw: 0.35 Amps

SKU	DESCRIPTION	COLOR	CASE QTY
B836A	Display Pack - light only	amber	72
B836R	Display Pack - light only	red	72
836BA	light only	amber	400
836BR	light only	red	400

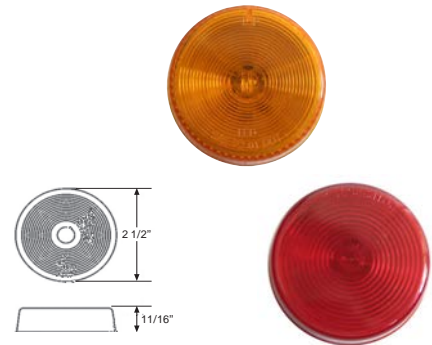

2" SEALED ROUND CLEARANCE MARKER

- Grommet mount installation
- Sealed light - Acrylic lens and ABS housing are sonic welded
- Accepts industry standard 2-prong plug
- Current draw: 0.35 Amps
- Twist in bulb socket

SKU	DESCRIPTION	COLOR	CASE QTY
B838A	Display Pack - light only	amber	72
B838R	Display Pack - light only	red	72
838BA	light only	amber	400
838BR	light only	red	400
838BAK	light, grommet and plug	amber	200
838BRK	light, grommet and plug	red	200



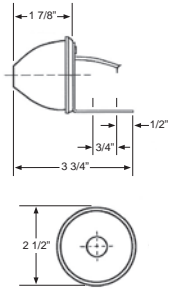

2 1/2" BEEHIVE CLEARANCE MARKER

- Mounts with included right angle bracket
- Acrylic lens snaps onto ABS housing
- Single-wire design grounds through the mounting hardware
- Current draw: 0.35 Amps
- Replacement bulb #67

SKU	DESCRIPTION	COLOR	CASE QTY
B666A	Display Pack - light and bracket	amber	72
B666R	Display Pack - light and bracket	red	72
B666C	Display Pack - light and bracket	clear	72
B666BL	Display Pack - light and bracket	blue	72

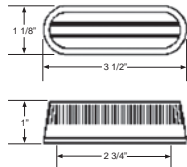

3 1/2" OBLONG SIDE/CLEARANCE MARKER

- Surface mount installation
- Acrylic lens snaps onto ABS housing
- Single-wire design grounds through the mounting hardware
- Current draw: 0.35 Amps
- Replacement bulb #194

SKU	DESCRIPTION	COLOR	CASE QTY
B487A	Display Pack - light only	amber	36
B487R	Display Pack - light only	red	36
B9487A	Display Pack - lens only	amber	36
B9487R	Display Pack - lens only	red	36

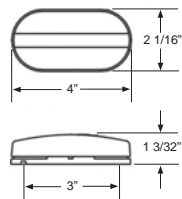

4" OBLONG SIDE/CLEARANCE MARKER WITH REFLEX

- Surface mount installation
- Acrylic lens snaps onto ABS housing
- Single-wire design grounds through the mounting hardware
- Current draw: 0.35 Amps
- Replacement bulb #193

SKU	DESCRIPTION	COLOR	CASE QTY
B499A	Display Pack - light only	amber	36
B499R	Display Pack - light only	red	36

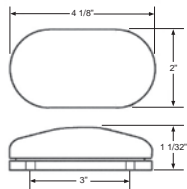

* 4 1/8" OBLONG DUAL BULB SIDE/CLEARANCE MARKER

- Surface mount installation
- Acrylic lens snaps onto ABS housing
- Two-wire design
- Current draw: 0.7 Amps
- Dual bulbs - if one burns out the other remains lit
- Replacement bulbs #57

SKU	DESCRIPTION	COLOR	CASE QTY
B482TW2A	Display Pack - light only	amber	72
B482TW2R	Display Pack - light only	red	72
B9610A	Display Pack - lens only	amber	36
B9610R	Display Pack - lens only	red	36

INCANDESCENT CLEARANCE MARKERS

4 1/8" OBLONG SIDE/CLEARANCE MARKER WITH REFLEX

- Surface mount installation
- Acrylic lens snaps onto ABS housing
- Single-wire design grounds through the mounting hardware
- Current draw: 0.3 Amps
- Replacement bulb #194

SKU	DESCRIPTION	COLOR	CASE QTY
B484W1A	Display Pack - light only	amber	36
B484W1R	Display Pack - light only	red	36
B9899A	Display Pack - lens only	amber	36
B9899R	Display Pack - lens only	red	36
T484W1BA	light only	amber	300
T484W1BR	light only	red	300

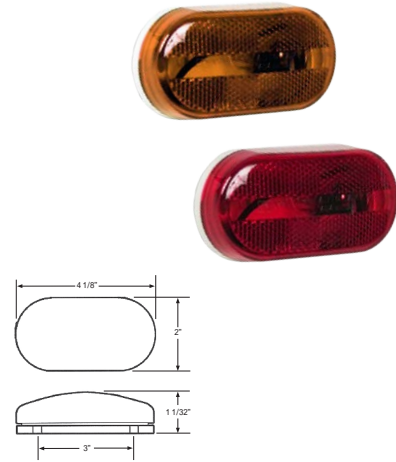

PC2
HATED
LIGHT

*4" RECTANGULAR DUAL BULB SIDE/CLEARANCE MARKER

- Surface mount installation
- Acrylic lens snaps onto ABS housing
- Single-wire design grounds through the mounting hardware
- Current draw: 0.7 Amps
- Dual bulbs - if one burns out the other remains lit
- Replacement bulbs #194

SKU	DESCRIPTION	COLOR	CASE QTY
B444A	Display Pack - light only	amber	72
B444R	Display Pack - light only	red	72
B9444A	Display Pack - lens only	amber	36
B9444R	Display Pack - lens only	red	36
T444BA	light only	amber	300
T444BR	light only	red	300

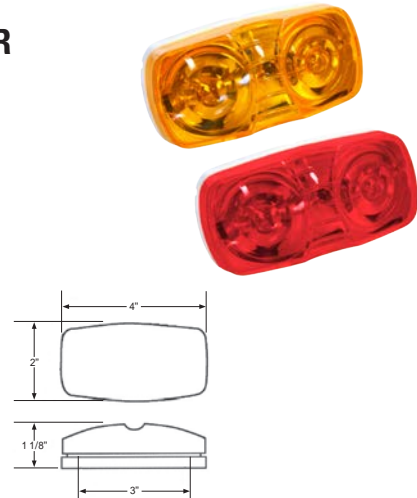

4" RECTANGULAR SIDE/CLEARANCE MARKER WITH REFLEX

- Surface mount installation
- Acrylic lens snaps onto ABS housing
- Single-wire design grounds through the mounting hardware
- Current draw: 0.3 Amps
- Replacement bulb #194

SKU	DESCRIPTION	COLOR	CASE QTY
483BA	light only	amber	300
483BR	light only	red	300

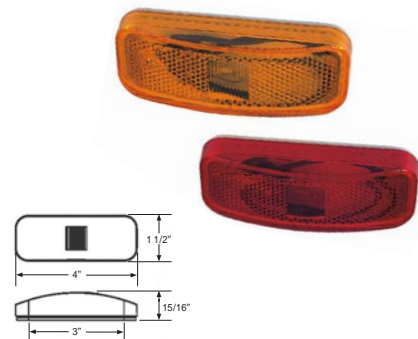

2" RECTANGULAR SIDE/CLEARANCE MARKER

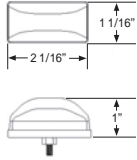

- Stud mount installation
- Sealed light - PC lens and ABS housing are sonic welded
- Single-wire design grounds through the mounting hardware
- Current draw: 0.3 Amps

SKU	DESCRIPTION	COLOR	CASE QTY
490BA	light only	amber	300

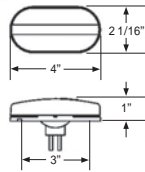

4" OBLONG SIDE/CLEARANCE MARKER WITH REFLEX

- Surface mount installation
- Sealed light - Acrylic lens and ABS housing are sonic welded
- Two-wire design
- Current draw: 0.3 Amps
- Twist-in bulb socket - Replacement bulb #194

SKU	DESCRIPTION	COLOR	CASE QTY
B480A	Display Pack - light only	amber	36
B480R	Display Pack - light only	red	36
480BA	light only	amber	50
480BR	light only	red	50

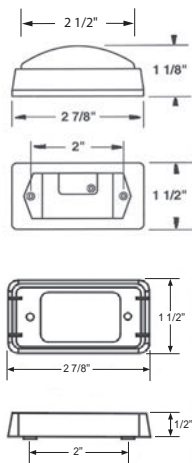

PC2 * 2 1/2" RECTANGULAR SIDE/CLEARANCE MARKER WITH REFLEX

- Surface mount installation
- Sealed light - Acrylic lens and ABS housing are sonic welded
- Accepts industry standard 2-prong plug
- Current draw: 0.3 Amps

SKU	DESCRIPTION	COLOR	CASE QTY
B485A	Display Pack - light, chrome bracket and wire	amber	72
B485R	Display Pack - light, chrome bracket and wire	red	72
B4851A	Display Pack - light only	amber	36
B4851R	Display Pack - light only	red	36
485BA	light only	amber	500
T485BA	light only	amber	300
T485BR	light only	red	300
485BC	light only - utility light	clear	500
93721	fender bracket only	-	200
92536BK	mounting kit - black bracket and plug	-	200
93875	plug only	-	500

INCANDESCENT CLEARANCE MARKERS

4" RECTANGULAR SIDE/CLEARANCE MARKER WITH REFLEX

- Surface mount installation
- Acrylic lens snaps onto ABS housing
- Single-wire design grounds through the mounting hardware
- Current draw: 0.35 Amps
- Replacement bulb #194

SKU	DESCRIPTION	COLOR	CASE QTY
B427A	Display Pack - light only	amber	36
B427R	Display Pack - light only	red	36

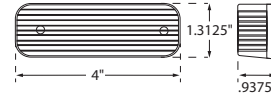

PC2 RATED LIGHT * 4" RECTANGULAR SIDE/CLEARANCE MARKER

- Surface mount installation
- Sealed light - PC lens and ABS housing are sonic welded
- Accepts industry standard 2-prong plug
- Current draw: 0.7 Amps

SKU	DESCRIPTION	COLOR	CASE QTY
B488A	Display Pack - light only	amber	36
B488R	Display Pack - light only	red	36
B488ARB	Display Pack - light only	amber/red	36
T488BA	light only	amber	300
T488BR	light only	red	300
488BA	light only	amber	400
488BAR	light only	amber/red	400
488BAKB	light, black bracket and plug	amber	200
488BRKB	light, black bracket and plug	red	200
488BARKB	light, black bracket and plug	amber/red	200
92232CK	chrome bracket and plug	-	500
92232C	mounting bracket - chrome	-	500
92232B	mounting bracket - black	-	500
92232BK	mounting kit - black bracket and plug	-	500

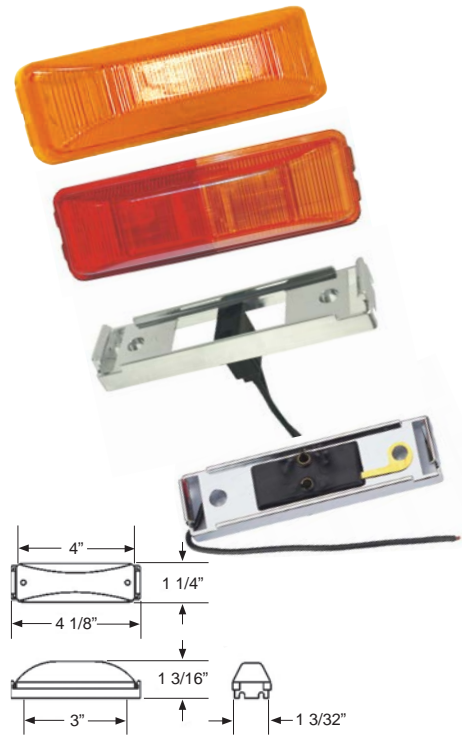

6" SIDE MARKER AND MID TURN SIGNAL WITH REFLEX

- Grommet mount installation
- Sealed light - Acrylic lens and ABS housing are sonic welded
- Accepts industry standard 3-prong plug
- Current draw: 3.0 Amps

SKU	DESCRIPTION	COLOR	CASE QTY
429BA	light only	amber	50
95233	grommet only	-	100
93874	plug only	-	500

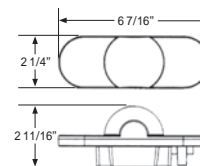
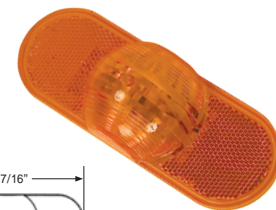

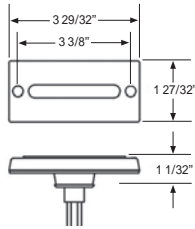
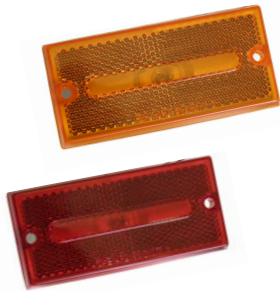

4" RECTANGULAR SIDE/CLEARANCE MARKER WITH REFLEX

- Surface mount installation - includes gasket
- Sealed light - Acrylic lens and ABS housing are sonic welded
- Two-wire design
- Current draw: 0.3 Amps
- Twist-in bulb socket - Replacement bulb #194

SKU	DESCRIPTION	COLOR	CASE QTY
B479A	Display Pack - light only	amber	36
B479R	Display Pack - light only	red	36

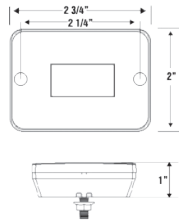
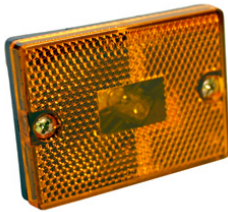

2 3/4" RECTANGULAR SIDE/CLEARANCE MARKER WITH REFLEX

- Stud mount installation
- Replaceable lens
- Single-wire design grounds through the mounting hardware
- Current draw: 0.3 Amps
- Replacement bulb #194

SKU	DESCRIPTION	COLOR	CASE QTY
B423A	Display Pack - light only	amber	36
B423R	Display Pack - light only	red	36
B9423A	Display Pack - lens only	amber	36
B9423R	Display Pack - lens only	red	36
T423BA	light only	amber	60
423BA	light only	amber	300
423BR	light only	red	300

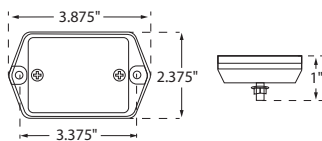
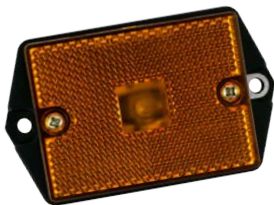

2 3/4" EAR MOUNT RECTANGULAR SIDE/CLEARANCE MARKER WITH REFLEX

- Surface mounts with ear mount base
- Replaceable lens
- Single-wire design grounds through the mounting hardware
- Current draw: 0.35 Amps
- Replacement bulb #194

SKU	DESCRIPTION	COLOR	CASE QTY
B495A	Display Pack - light only	amber	18
T495BA	light only	amber	50

INCANDESCENT CLEARANCE MARKERS

TEAR DROP MARKER LIGHT

- Surface mount installation - includes gasket
- Durable polycarbonate lens and ABS plastic housing
- Two-wire design
- Current draw: 0.35 Amps
- Replacement bulb #67

SKU	DESCRIPTION	COLOR	CASE QTY
B472FA	Display Pack - light only	amber	24
DF472CAK	Display Pack - 5 light kit	amber	12

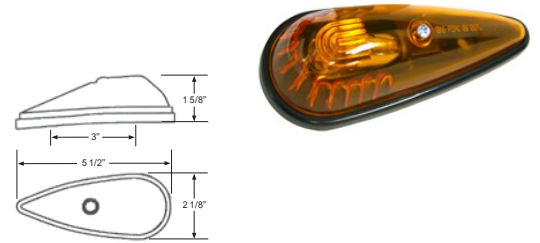

4 7/8" ARMORED SIDE/CLEARANCE MARKER

- Surface mount installation
- Chrome plated armored housing protects lens and bulb
- Single-wire design grounds through the mounting hardware
- Current draw: 0.3 Amps
- Replacement bulb #194

SKU	DESCRIPTION	COLOR	CASE QTY
B478A	Display Pack - light only	amber	24
B478R	Display Pack - light only	red	24
T478BA	light only	amber	144
T478BR	light only	red	144

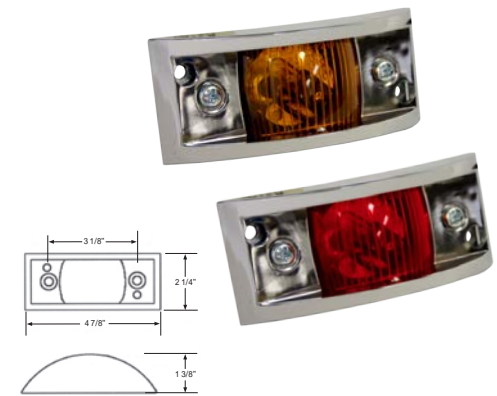

3 1/4" RECTANGULAR SIDE/CLEARANCE MARKER

- Surface mounts with ear mount base
- Acrylic lens snaps onto ABS base
- Single-wire design grounds through the mounting hardware
- Current draw: 0.3 Amps
- Replacement bulb #194

SKU	DESCRIPTION	COLOR	CASE QTY
B486CAK	Display Pack - 6 light kit	amber	24
B486CRK	Display Pack - 6 light kit	red	24
B486A	Display Pack - light only	amber	36
B486R	Display Pack - light only	red	36
B486BL	Display Pack - light only	blue	36
B9486A	Display Pack - lens only	amber	36
B9486R	Display Pack - lens only	red	36
486BA	light only	amber	500
486BR	light only	red	500

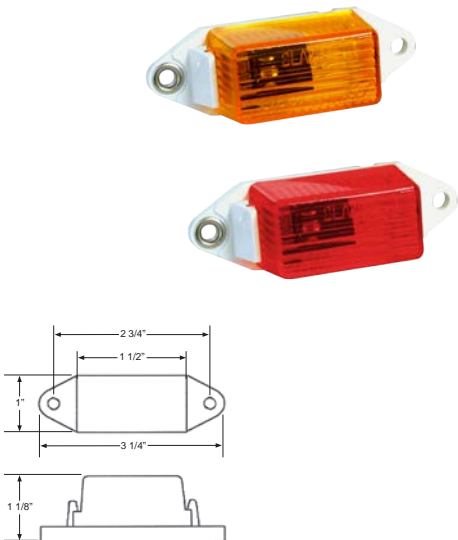



12 PC 3 1/2" OBLONG SIDE/CLEARANCE MARKER KIT

- Kit includes: 12 lights, mounting hardware and wiring
- Acrylic lens snaps onto ABS housing
- Single-wire design grounds through mounting hardware
- Current draw: 0.35 Amps
- Replacement bulb #194

SKU	DESCRIPTION	COLOR	CASE QTY
C487CAK	Display Pack - lights and wiring	amber	24



SEALED IDENTIFICATION LIGHT BAR

- Surface mount installation
- Black polycarbonate base mounted with 3 sealed lights
- 50" two-wire design
- Current draw: 1.1 Amps
- Replaceable clearance lights - Blazer®# B488R

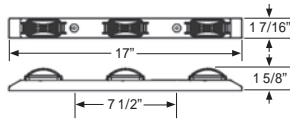

SKU	DESCRIPTION	COLOR	CASE QTY
B3485R	Display Pack - ID light bar	red	24
3485BR	ID light bar	red	50



IDENTIFICATION LIGHT BAR

- Surface mount installation
- Black polycarbonate base mounted with 3 lights and removable lenses
- 10" two-wire design
- Current draw: 1.1 Amps
- Replacement bulb #194

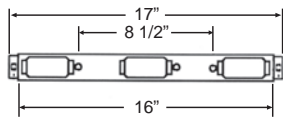

SKU	DESCRIPTION	COLOR	CASE QTY
3486R	Display Pack - ID light bar	red	24
3486BR	ID light bar	red	50



IDENTIFICATION LIGHT BAR

- Surface mount installation
- White steel base mounted with 3 lights and removable lenses
- 50" single-wire grounds through the mounting hardware
- Current draw: 1.1 Amps
- Replaceable clearance lights - Blazer®# B486A

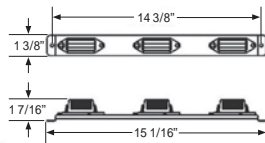

SKU	DESCRIPTION	COLOR	CASE QTY
B3489A	Display Pack - ID light bar	amber	24
B3489R	Display Pack - ID light bar	red	24
3489R	ID light bar	red	100

INCANDESCENT CLEARANCE MARKERS

STAINLESS STEEL SEALED IDENTIFICATION LIGHT BAR

- Surface mount installation
- Stainless steel base mounted with 3 sealed lights
- 50" single-wire grounds through the mounting hardware
- Current draw: 1.1 Amps

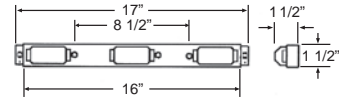

SKU	DESCRIPTION	COLOR	CASE QTY
3483BR	ID light bar	red	50

INCANDESCENT STOP/TAIL/TURN



Featuring the B85RK

- DOT approved – Meets FMVSS108 and CMVSS 108 Safety Standards ensuring that you are using approved lighting
- Durable housing and lens protect against corrosion
- Retail and bulk configurations available

SUBMERSIBLE COMBINATION STOP/TAIL/TURN LIGHT - OVER AND UNDER 80"

- 82B serves 8 functions: Stop, Turn, Tail, Rear Clearance, Rear Reflex, Side Marker, Side Reflex, and License Plate Illuminator
- 92B serves 7 functions: Stop, Turn, Tail, Rear Clearance, Rear Reflex, Side Marker and Side Reflex Stud mount installation
- Acrylic lens with gasket creates air pocket, preventing water from corroding bulb
- Current draw: 3.5 Amps
- Replacement bulbs #168 and #1157

SKU	DESCRIPTION	COLOR	CASE QTY
82B	8-function - left hand side replacement	red	50
92B	7-function - right hand side replacement	red	50
B983	Display Pack - S/T/T lens only	red	36
T983B	S/T/T lens only	red	300

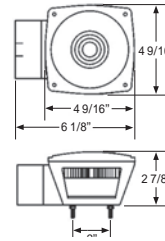

COMBINATION STOP/TAIL/TURN LIGHT - UNDER 80"

- B83 (T83B left side replacement) serves 7 functions: Stop, Turn, Tail, Rear Clearance, Rear Reflex, Side Marker and License Plate Illuminator
- B93 (T93B right side replacement) serves 6 functions: Stop, Turn, Tail, Rear Clearance, Rear Reflex and Side Marker
- Replacement lights for C6423 trailer light kit
- Stud mount installation
- ABS housing and durable acrylic lens protect against corrosion
- Current draw: 3.5 Amps
- Replacement bulbs #168 and #1157

SKU	DESCRIPTION	COLOR	CASE QTY
B83	Display Pack - left hand side replacement	red	24
83QB	quick connect - left hand light only	red	50
T83B	left hand light only	red	48
B93	Display Pack - right hand side replacement	red	24
93QB	quick connect - right hand light only	red	50
T93B	right hand light only	red	48
B983	Display Pack - S/T/T lens only	red	36
T983B	S/T/T lens only	red	300

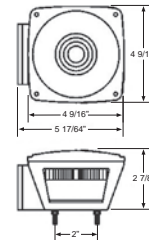

SUBMERSIBLE COMBINATION STOP/TAIL/TURN LIGHT - UNDER 80"

- C81 (left side replacement) serves 7 functions: Stop, Turn, Tail, Rear Clearance, Rear Reflex, Side Marker and License Plate Illuminator
- C91 (right side replacement) serves 6 functions: Stop, Turn, Tail, Rear Clearance, Rear Reflex and Side Marker
- Replacement lights for the C6421 trailer light kit
- Light life prolonged by "Belljar Principle" design requiring no seals or adhesives
- Acrylic lens with gasket creates air pocket, preventing water from corroding bulb
- Current draw 3.5 Amps
- Replacement bulbs #168 and #1157

SKU	DESCRIPTION	COLOR	CASE QTY
C81	Display Pack - left hand side replacement	red	24
C91	Display Pack - right hand side replacement	red	24

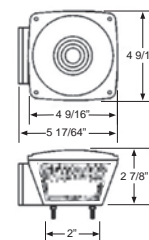

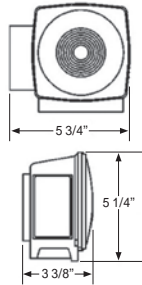

SUBMERSIBLE STOP/TAIL/TURN LIGHT - OVER AND UNDER 80"

- B84 serves 8 functions: Stop, Turn, Tail, Rear Clearance, Rear Reflex, Side Marker, Side Reflex, and License Plate Illuminator
- B94 serves 7 functions: Stop, Turn, Tail, Rear Clearance, Rear Reflex, Side Marker and Side Reflex
- Replacement lights for C6424 trailer light kit
- Side or back mounting options
- Housing and lens are sonic welded to create a sealed light
- Current draw: 3.5 Amps
- Replacement bulbs #194 and #1157

SKU	DESCRIPTION	COLOR	CASE QTY
B84	Display Pack 8-function - left hand side replacement	red	24
84QB	quick connect - left hand light only	red	50
B94	Display Pack 7-function - right hand side replacement	red	24
94QB	quick connect - right hand light only	red	50

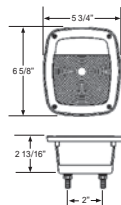

UNIVERSAL HEAVY-DUTY STOP/TAIL/TURN LIGHT

- Surface mount installation - Unique back plate design allows for numerous stud positions to fit all applications
- ABS housing and durable acrylic lens protect against corrosion
- Current draw: 3.5 Amps
- Replacement bulbs #1156 and #2057

SKU	DESCRIPTION	COLOR	CASE QTY
B99SW	Display Pack - light only	red	24
B999R	Display Pack - lens only	red	36

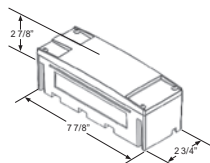

LOW-PROFILE SUBMERSIBLE STOP/TAIL/TURN LIGHT - OVER AND UNDER 80"

- B80 serves 8 functions: Stop, Turn, Tail, Rear Clearance, Rear Reflex, Side Marker, Side Reflex, and License Plate Illuminator
- B90 serves 7 functions: Stop, Turn, Tail, Rear Clearance, Rear Reflex, Side Marker and Side Reflex
- Replacement lights for the C6288 trailer light kit
- Sealed capsule prevents premature bulb failure and corrosion
- Current draw: 3.5 Amps
- Replacement bulbs #194 and #1157

SKU	DESCRIPTION	COLOR	CASE QTY
B80	Display Pack 8-function - left hand side replacement	red	24
80B	left hand light only	red	48
B90	Display Pack 7-function - right hand side replacement	red	24
90B	right hand light only	red	48

LOW-PROFILE SUBMERSIBLE STOP/TAIL/TURN LIGHT - OVER AND UNDER 80"

- 784B serves 8 functions: Stop, Turn, Tail, Rear Clearance, Rear Reflex, Side Marker, Side Reflex, and License Plate Illuminator
- 794B serves 7 functions: Stop, Turn, Tail, Rear Clearance, Rear Reflex, Side Marker and Side Reflex
- Replacement lights for the C6285 trailer light kit
- Light life prolonged by "Belljar Principle" design requiring no seals or adhesives
- Current draw: 3.5 Amps
- Replacement bulbs #194 and #1157

SKU	DESCRIPTION	COLOR	CASE QTY
87B	Display Pack 8-function - left hand side replacement	red	50
97B	Display Pack 7-function - right hand side replacement	red	50

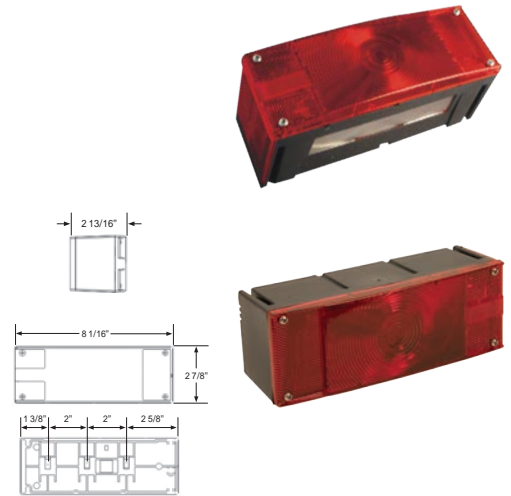

4" ROUND FLANGE MOUNT STOP/TAIL/TURN LIGHT

- Flange mount installation - requires 4-1/2" cutout
- Steel housing and durable acrylic lens protect against corrosion
- Two-wire design
- Current draw: 3.0 Amps
- Replacement bulb #2057

SKU	DESCRIPTION	COLOR	CASE QTY
B430BLK	Display Pack - light and housing	red	24
T430BLKB	light and housing	red	96
B9216R	lens only	red	36



4" ROUND STOP/TAIL/TURN LIGHT

- Grommet mount installation
- Resin housing and polycarbonate lens are sonic welded to create a sealed light
- Accepts industry standard 3-prong plug
- Current draw: 3.0 Amps

SKU	DESCRIPTION	COLOR	CASE QTY
B95	Display Pack - light, grommet and plug	red	24
B95S	Display Pack - light only	red	24
B95C	Display Pack - back-up light, grommet and plug	white	24
95BRK	light, grommet and plug	red	50
T95BR	light, grommet and plug	red	50
B95227	Display Pack - grommet only	-	24
B93874	Display Pack - plug only	-	36



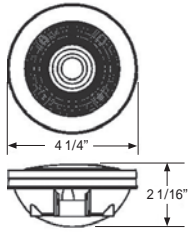

4" STOP/TAIL/TURN LIGHT WITH REFLEX

- Grommet mount installation
- Resin housing and polycarbonate lens are sonic welded to create a sealed light
- Accepts industry standard 3-prong plug
- Current draw: 2.5 Amps

SKU	DESCRIPTION	COLOR	CASE QTY
915BR	light only with reflex reflector	red	100
915BRK	light, grommet and plug	red	50

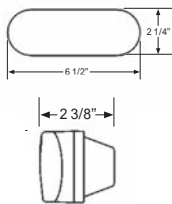

6" OVAL STOP/TAIL/TURN LIGHT

- Grommet mount installation
- Resin housing and polycarbonate lens are sonic welded to create a sealed light
- Accepts industry standard 3-prong plug
- Current draw: 3.0 Amps

SKU	DESCRIPTION	COLOR	CASE QTY
B85RK	Display Pack - S/T/T light, grommet and plug	red	24
B85R	Display Pack - light only	red	24
B85AK	Display Pack - tail and turn light, grommet and plug	amber	24
T85BR	S/T/T light	red	50
85BR	S/T/T light	red	100
85BRK	S/T/T light, grommet and plug	red	50
85BA	tail and turn light	amber	100
95233	grommet only	-	100
93874	plug only	-	500

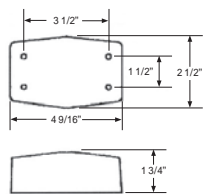

RECTANGULAR STOP/TAIL/TURN LIGHT

- Surface mount installation
- Steel housing and durable polycarbonate lens protect against corrosion
- Two-wire design grounds through the mounting hardware
- Current draw: 3.0 Amps
- Replacement bulb #2057

SKU	DESCRIPTION	COLOR	CASE QTY
B465A	tail and turn light	amber	24
B465R	S/T/T light	red	24

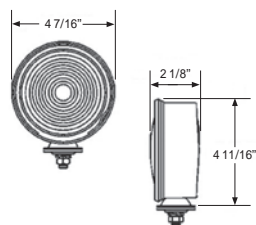

ROUND SINGLE FACE STOP/TAIL/TURN LIGHT

- Pedestal mount installation
- Steel housing and durable acrylic lens protect against corrosion
- Two-wire design grounds through the mounting post
- Current draw: 3.0 Amps
- Replacement bulb #2057

SKU	DESCRIPTION	COLOR	CASE QTY
B3552R	Display Pack - light only	red	24
T3552BR	light only	red	96
B9216R	Display Pack - lens	red	36

4 5/16" ROUND DOUBLE FACED STOP/TAIL/TURN LIGHT

- Pedestal mount installation
- Amber lens side for parking and turn functions and red lens on the other for stop, turn and tail functions
- Two-wire design grounds through the mounting post
- Current draw: 3.0 Amps
- Replacement bulb #2057

SKU	DESCRIPTION	COLOR	CASE QTY
B567	Display Pack - dual faced light only	red/amber	24
B567-1AA	Display Pack - dual faced light only	amber	24
B567-2R	Display Pack - single faced light only	red	24
567-2R	single faced light only	red	50
T5672AAB	dual faced light only	amber/ amber	48
T5672ARB	dual faced light only	amber/red	48



3 7/8" ROUND METAL STOP/TAIL/TURN LIGHT

- Surface mount installation - universal mounting plate
- Enamel-coated steel housing and durable acrylic lens protect against corrosion
- Two-wire design grounds through the mounting post
- Current draw: 3.0 Amps
- Replacement bulb #1157

SKU	DESCRIPTION	COLOR	CASE QTY
B55UW	Display Pack - light only	red	24
T55SWB	stop and tail - light only	red	100
B9460R	Display Pack - lens only	red	24



RV STOP/TAIL/TURN LIGHT WITH REFLEX

- Surface mount installation
- ABS housing and durable acrylic lens protect against corrosion
- Three-wire design
- Current draw: 3.5 Amps
- Replacement bulb #1157

SKU	DESCRIPTION	COLOR	CASE QTY
B1002R	Display Pack - light only	red	24
B1003R	Display Pack - light only with back-up	red	24
B1004R	Display Pack - light only with license illuminator and bracket	red	24
B1005R	Display Pack - light only with back up, license illuminator and bracket	red	24



INCANDESCENT TRAILER LIGHT KITS



Featuring the C6421

- DOT approved – Meets FMVSS108 and CMVSS 108 Safety Standards ensuring that you are using approved lighting
- All Blazer® Incandescent trailer light kits come with necessary wiring, brackets, mounting hardware and instructions to install your lights
- Available in standard and submersible configurations

LOW-PROFILE, SEALED CAPSULE SUBMERSIBLE TRAILER LIGHT KIT - OVER AND UNDER 80"

- Kit includes 2 S/T/T lights, 20' wiring harness with 4-flat connector, corrosion resistant license plate bracket, mounting hardware and instructions
- Sealed capsule prevents premature bulb failure and corrosion
- ABS plastic housing and durable acrylic lens provide protection against corrosion
- Current draw: 3.5 Amps / side
- Replacement bulbs #194 and #2057

SKU	DESCRIPTION	COLOR	CASE QTY
C6288	Display Pack - trailer light kit	red	8
B80	Display Pack - light only	red	24
B90	Display Pack - light only	red	24



LOW-PROFILE SUBMERSIBLE TRAILER LIGHT KIT - OVER AND UNDER 80"

- Kit includes 2 S/T/T lights, 20' wiring harness with 4-flat connector, corrosion resistant license plate bracket, mounting hardware and instructions
- Light life prolonged by "Belljar Principle" design requiring no seals or adhesives
- ABS plastic housing and durable acrylic lens provide protection against corrosion
- Current draw: 3.5 Amps / side
- Replacement bulbs #194 and #1157

SKU	DESCRIPTION	COLOR	CASE QTY
C6285	Display Pack - trailer light kit	red	12
87B	light only - left hand side	red	50
97B	light only - right hand side	red	50



TWO-SIDED MAGNETIC TOWING LIGHT KIT - UNDER 80"

- Kit includes 2 towing lights and 20' wiring harness with 4-flat connector
- Front side shine amber and back shine red
- Provides DOT compliant stop, turn and tail functions for your trailer or towed vehicle
- Tough polycarbonate base and lens and non-scratch, heavy-duty magnetic base for secure mount
- Current draw: 2.0 Amps / side

SKU	DESCRIPTION	COLOR	CASE QTY
C6300	Display Pack - towing light kit	amber / red	10
6302	Display Pack - towing light kit with carrying case	amber / red	6





SUBMERSIBLE COMBINATION TRAILER LIGHT KIT - UNDER 80"

- Kit includes 2 S/T/T lights, 20' wiring harness with 4-flat connector, corrosion resistant license plate bracket, mounting hardware and instructions
- Light life prolonged by "Belljar Principle" design requiring no seals or adhesives
- Acrylic lens with gasket creates air pocket, preventing water from corroding bulb
- Current draw: 3.5 Amps / side
- Replacement bulbs #168 and #1157

SKU	DESCRIPTION	COLOR	CASE QTY
C6421	Display Pack - trailer light kit	red	12
C81	Display Pack - left hand side	red	24
C91	Display Pack - right hand side	red	24



COMBINATION STOP/TAI/TURN LIGHT - UNDER 80"

- Kit includes 2 S/T/T lights, 2 side markers, 20' wiring harness with 4-flat connector, corrosion resistant license plate bracket, mounting hardware and instructions
- Stud-mount installation
- ABS housing and durable acrylic lens protect against corrosion
- Current draw: 3.5 Amps / side
- Replacement bulbs #168 and #1157

SKU	DESCRIPTION	COLOR	CASE QTY
C6423	Display Pack - trailer light kit	amber/red	12
B83	Display Pack - left hand side light	red	24
B93	Display Pack - right hand side light	red	24



SUBMERSIBLE COMBINATION STOP/TAI/TURN LIGHT - OVER AND UNDER 80"

- Kit includes 2 S/T/T lights, 20' wiring harness with 4-flat connector, corrosion resistant license plate bracket, mounting hardware and instructions
- Light life prolonged by "Belljar Principle" design requiring no seals or adhesives
- Side or back mounting options
- Current draw 3.5 Amps / side
- Replacement bulbs #194 and #1157

SKU	DESCRIPTION	COLOR	CASE QTY
C6424	Display Pack - trailer light kit	red	12
B84	Display Pack - left hand side light	red	24
B94	Display Pack - right hand side light	red	24

WARNING/EMERGENCY



Featuring the C4855AW

- Halogen, incandescent and LED warning lights available
- Convenient 12 V plug or battery powered options for easy installation
- Blazer® warning products provide high performance and improved visibility in all types of weather conditions
- Non-scratch, heavy-duty magnetic base for secure mount

HALOGEN REVOLVING LIGHT BAR

- 12' power cord includes plug with on/off switch
- Polycarbonate lens and base for superior performance in all weather conditions
- Non-scratch, heavy-duty magnetic base for secure mount
- Features 2 revolving, chrome reflectors with 2 replaceable H1 55W bulbs
- Current draw: 3.04 Amps

SKU	DESCRIPTION	# OF FLASH PATTERNS	CASE QTY
C4500AW	Display Pack	1	4

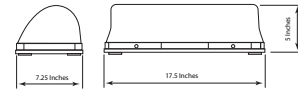

LED CLASS 2 WARNING LIGHT BAR

- 12' power cord includes plug with on/off and pattern selection switch
- Polycarbonate lens and base for superior performance in all weather conditions
- Non-scratch, heavy-duty magnetic base for secure mount
- Current draw: 2.96

SKU	DESCRIPTION	# OF FLASH PATTERNS	CASE QTY
C4850AW	Display Pack	21	2

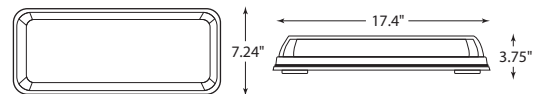

LED LOW-PROFILE WARNING LIGHT BAR

- 12' power cord includes plug with on/off and pattern selection switch
- Polycarbonate lens and base for superior performance in all weather conditions
- Non-scratch, heavy-duty magnetic base for secure mount
- Current draw: 1.17 Amps

SKU	DESCRIPTION	# OF FLASH PATTERNS	CASE QTY
C4855CAW	Display Pack - amber lens	7	4
C4855AW	Display Pack - clear lens/amber LEDs	7	4
C4855CAC	Display Pack - clear lens/amber & white LEDs*	9	4

*Includes amber only and white only patterns.

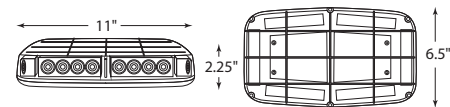

LED LOW-PROFILE ALERT BEACON

- Clear lens with amber LEDs
- 12' power cord includes plug with on/off and pattern selection switch
- Polycarbonate lens and base for superior performance in all weather conditions
- Non-scratch, heavy-duty magnetic base for secure mount
- Current draw: 1.46 Amps

SKU	DESCRIPTION	# OF FLASH PATTERNS	CASE QTY
C38CAW	Display Pack	8	2

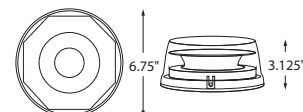

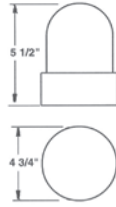

REVOLVING ALERT BEACON

- 12' power cord includes 12 V plug
- Friction drive motor - no mechanical noise
- Non-scratch, heavy-duty magnetic base for secure mount
- Replacement bulb #67
- Current draw 0.2 Amps

SKU	DESCRIPTION	# OF FLASH PATTERNS	CASE QTY
C45AW	Display Pack	1	12

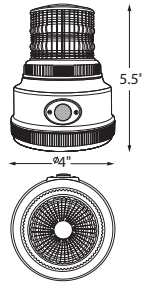

LED MAGNETIC WARNING BEACON

- No wiring necessary — operates on 2-D batteries (not included)
- Features an on/off sensor setting that will automatically turn the light on in darkness and off in daylight
- Non-scratch, heavy-duty magnetic base for secure mount

SKU	DESCRIPTION	# OF FLASH PATTERNS	CASE QTY
C43A	Display Pack	4	12

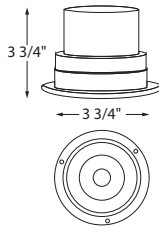

LED STROBE BEACON

- 12' power cord includes 12 V plug
- Polycarbonate lens and base for superior performance in all weather conditions
- Non-scratch, heavy-duty magnetic base for secure mount
- Optional permanent mount - hardware (not included)
- Current draw: 0.03 Amps

SKU	DESCRIPTION	# OF FLASH PATTERNS	CASE QTY
C48AW	Display Pack	1	12

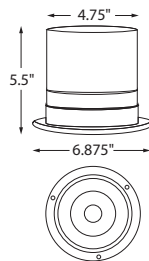

LED STANDARD PROFILE ALERT BEACON

- 12' power cord includes 12 V plug and pattern selection button
- Polycarbonate lens and base for superior performance in all weather conditions
- Non-scratch, heavy-duty magnetic base for secure mount
- Optional permanent mount - hardware (not included)
- Current draw: 0.62 Amps

SKU	DESCRIPTION	# OF FLASH PATTERNS	CASE QTY
C40AW	Display Pack	8	12

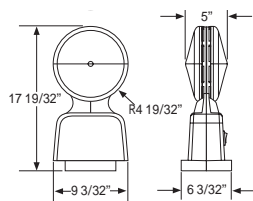

LED MAGNETIC HAZARD LIGHT

- No wiring necessary — operates on 4-AA batteries (not included)
- Polycarbonate lens and base for superior performance in all weather conditions
- Non-scratch, heavy-duty magnetic base for secure mount
- Base includes on/off switch

SKU	DESCRIPTION	# OF FLASH PATTERNS	CASE QTY
C42A	Display Pack	1	4

LED MAGNETIC EMERGENCY LIGHT

- No wiring necessary — operates on 4-AA batteries (not included)
- Dual function - constant on or flash mode - visible over 1 mile
- Non-scratch, heavy-duty magnetic mount or freestanding setup
- C6355 has an additional work light on the side of the unit

SKU	DESCRIPTION	# OF FLASH PATTERNS	CASE QTY
C6350	Display Pack - red	2	12
C6350A	Display Pack - amber	2	12
C6355	Display Pack - red with white work light	2	12

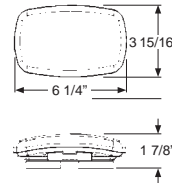

C6355 WORK LIGHT

LED STROBE LIGHT KIT

- Kit includes: 2 light modules, wiring harness with on/off and pattern selection switch and mounting hardware
- High visibility - 1W white LED x 4 modules per light
- High impact polycarbonate lens - won't discolor
- Compact design - fits discretely on multiple vehicle surface locations
- Current draw: 0.76 Amps

SKU	DESCRIPTION	# OF FLASH PATTERNS	CASE QTY
C4845	Display Pack	18	4

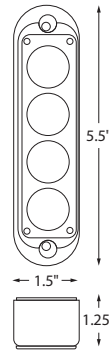

FOG & DRIVING



Featuring the DF1075KB

- Auxiliary lighting designed to complement and enhance any vehicle's factory head lamps while providing further visibility
- LED and halogen lighting kits come with 2 lamps, wiring kit, on/off switch, mounting hardware and installation instructions
- Fog and driving lights feature corrosion resistant housing and durable lenses provide protection against the elements

SNOW PLOW LIGHT KIT

- Kit includes 2 lights, wiring kit, on/off switch, mounting hardware and installation instructions
- Dual filament headlamps provide low and high beams, turn signal and parking light functions
- Pedestal mount installation
- Replaceable H4666 or H6545 sealed beam headlamps and #2357 bulb for turn signal
- Current draw: 7.2 Amps

SKU	DESCRIPTION	COLOR	CASE QTY
C8050K	Display Pack	white/amber	2

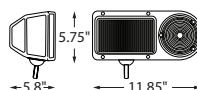

BAJA® 6 1/4" ROUND 100W OFF-ROAD LIGHT

- Heavy-duty steel housing with stainless steel rims and double insulated glass lens
- 2-wire design - Wire leads are protected by flexible metal conduit
- Replaceable 100 Watt quartz halogen bulb
- Off-road use only
- Current draw: 6.0 Amps

SKU	DESCRIPTION	CASE QTY
C52CW	Display Pack	8

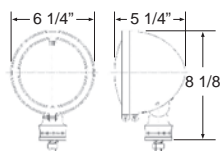

BAJA® 6 1/2" ROUND HALOGEN OFF-ROAD TRUCK LIGHT KIT

- Kit includes 2 lights, wiring kit, illuminated on/off switch, mounting brackets, hardware and installation instructions
- ABS plastic housing and durable polycarbonate provide protection against the elements
- Each lamp features a rock guard to protect lens from flying debris
- Replaceable 12V/55W/H3 bulbs
- Current draw: 3.0 Amps

SKU	DESCRIPTION	CASE QTY
N9002K	Display Pack	2

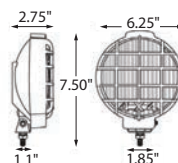

BAJA® 5" ROUND HALOGEN OFF-ROAD TRUCK LIGHT KIT

- Kit includes 2 lights, wiring kit, illuminated on/off switch, mounting brackets, hardware and installation instructions
- ABS plastic housing and durable polycarbonate provide protection against the elements
- Lamps feature a rock guard to protect lens from flying debris
- Off-road use only
- Current draw: 3.0 Amps

SKU	DESCRIPTION	CASE QTY
DF3619	Display Pack	12

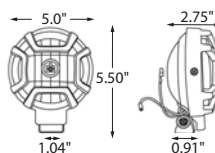

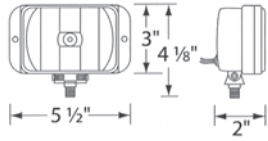

BAJA® AMBER FOG LIGHT KIT

- Kit includes 2 lights, wiring kit, illuminated on/off switch, mounting brackets, hardware and installation instructions
- Steel housing and amber colored glass lens provide protection against the elements
- Bottom vented to burn off internal condensation
- Replaceable 12V/55W/H3 bulbs
- Current draw: 5.0 Amps

SKU	DESCRIPTION	CASE QTY
DF1075KB	Display Pack	12

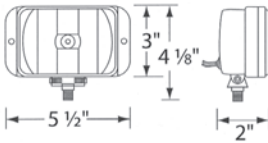

BAJA® ALL WEATHER FOG LIGHT KIT

- Kit includes 2 lights, wiring kit, illuminated on/off switch, mounting brackets, hardware and installation instructions
- ABS plastic housing and crystal coated glass lens provide protection against the elements
- Bottom vented to burn off internal condensation
- Replaceable 12V/55W/H3 bulbs
- Current draw: 5.0 Amps

SKU	DESCRIPTION	CASE QTY
DF1077KB	Display Pack	12

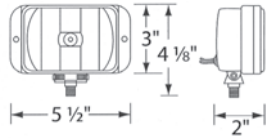

BAJA® DRIVING LIGHT KIT

- Kit includes 2 lights, wiring kit, illuminated on/off switch, mounting brackets, hardware and installation instructions
- ABS plastic housing and glass lens provide protection against the elements
- Bottom vented to burn off internal condensation
- Replaceable 12V/55W/H3 bulbs
- Current draw: 5.0 Amps

SKU	DESCRIPTION	CASE QTY
DF1073KB	Display Pack	12

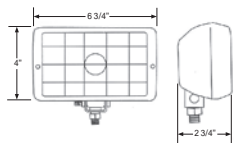

BAJA® RECTANGULAR DRIVING LIGHT KIT

- Kit includes 2 lights, lens covers, wiring kit, illuminated on/off switch, mounting brackets, hardware and installation instructions
- ABS plastic housing and glass lens provide protection against the elements
- Lamps feature a rock guard to protect lens from flying debris
- For ON or OFF road use - Designed to meet SAE requirements for driving lights
- Current draw: 5.0 Amps

SKU	DESCRIPTION	CASE QTY
CW8002K	Display Pack	2

BAJA® 3 7/8" ROUND HALOGEN DRIVING LIGHT KIT

- Kit includes 2 lights, wiring kit, illuminated on/off switch, mounting brackets, hardware and installation instructions
- Heavy-duty steel housing and durable polycarbonate provide protection against the elements
- Replaceable 12V/55W/H3 bulb
- C3062KBL has a blue lens which emits a bright, white light
- Current draw: 3.2 Amps

SKU	DESCRIPTION	CASE QTY
C3062K	Display Pack - clear lens	12
C3062KBL	Display Pack - blue lens	12

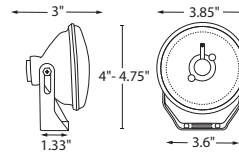

BAJA® LED 3 1/2" ROUND OFF-ROAD DRIVING LIGHT KIT

- Kit includes 2 lights, wiring kit, illuminated on/off switch, mounting brackets, hardware and installation instructions
- Die cast aluminum housing and durable polycarbonate lens provide protection against the elements
- 283 effective lumens
- Off-road use only
- Current draw: 0.6 Amps

SKU	DESCRIPTION	CASE QTY
C3067K	Display Pack	12

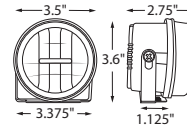

AXXENT™ 6" LOW-PROFILE AUXILIARY LIGHT KIT

- Kit includes 2 lights, wiring kit, illuminated on/off switch, mounting brackets, hardware and installation instructions
- ABS Plastic housing and durable PMMA lens provide protection against the elements
- Current draw: 0.08 Amps

SKU	DESCRIPTION	CASE QTY
AX4040K	Display Pack - "Try Me"	12

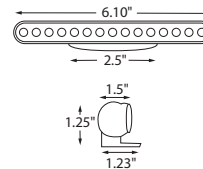

AXXENT™ 8 3/4" LOW-PROFILE AUXILIARY LIGHT KIT

- Kit includes 2 lights, wiring kit, illuminated on/off switch, mounting brackets, hardware and installation instructions
- ABS Plastic housing and durable PMMA lens provide protection against the elements
- Current draw: 0.04 Amps

SKU	DESCRIPTION	CASE QTY
AX4010K	Display Pack	12

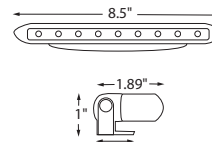

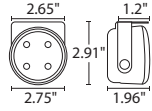

AXXENT™ 2 3/4" ROUND AUXILIARY LIGHT KIT

- Kit includes 2 lights, wiring kit, illuminated on/off switch, mounting brackets, hardware and installation instructions
- ABS plastic housing and durable PMMA lens provide protection against the elements
- Current draw: 0.12 Amps

SKU	DESCRIPTION	CASE QTY
AX4020K	Display Pack	12

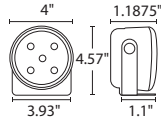

AXXENT™ 4" ROUND AUXILIARY LIGHT KIT

- Kit includes 2 lights, wiring kit, illuminated on/off switch, mounting brackets, hardware and installation instructions
- ABS plastic housing and durable PMMA lens provide protection against the elements
- Current draw: 0.04 Amps

SKU	DESCRIPTION	CASE QTY
AX4050K	Display Pack	12



3" ROUND AUXILIARY DRIVING LIGHT KIT

- Kit includes 2 lights, wiring kit, illuminated on/off switch, mounting brackets, hardware and installation instructions
- ABS plastic housing and heavy-duty glass lens provide protection against the elements
- Current draw: 3.0 Amps

SKU	DESCRIPTION	CASE QTY
RE1088B	Display Pack	12



COMPLETE WIRING KIT

- Kit includes 40 amp relay, illuminated on/off switch and all connectors and fuses
- Switch is rated at 15 amps and 15 VDC
- Control and power circuits have in-line fuses

SKU	DESCRIPTION	CASE QTY
MM510	Display Pack	48



2 PK HALOGEN FOG LAMP REPLACEMENT BULBS

- Blue coated H10 with right angle base
- Blue coating provides a white, brighter more efficient light

SKU	DESCRIPTION	CASE QTY
DF-H10BP-2	Display Pack	100

2 PK HALOGEN FOG LAMP REPLACEMENT BULBS

- Blue coated H10 with bullet connector
- Blue coating provides a white, brighter more efficient light

SKU	DESCRIPTION	CASE QTY
DF-880BP-2	Display Pack	100



OFF-ROAD LIGHTING & ACCESSORIES



Featuring the CWL515

- Blazer® off-road lights provide quality performance and durability in any off-road application
- Blazer off-road lights feature: high-output LEDs, aluminum housing, high-impact lenses, weatherproof IP-67 rating, adjustable mounting bracket and hardware and are compatible with 12-24 V systems
- All Blazer off-road accessories are compatible with Blazer LED off-road lights
- Check local laws before installing off-road lights on to your vehicle

OFF-ROAD LIGHTING & ACCESSORIES



LED 24" DOUBLE ROW LIGHT BAR KIT WITH REMOTE

- Includes light, mounting bracket, hardware, WMS module, remote and instructions
- Light bar includes a 9' lead wire
- Ability to run 4+ lights (2 each at 18 amps and 2 amps) with included remote control
- Fast & easy installation – no drilling, no wiring, no switch, no relay

SKU	DESCRIPTION	LUMENS (PER LIGHT)		DIODES	AMP DRAW	BEAM PATTERN	LIGHT TEMP. (K)	CASE QTY
		RAW	EFFECTIVE					
CWL52450	Display Pack	7200	6090	48 x 3W	4.8	spot/flood	6000	2

See CWL512, page 61 for specs



Fast & easy setup!

- No drilling
- No wiring
- No switch
- No relay



1 REMOTE

2 2" CUBES

3 9' LEAD

4 MODULE

5 BATTERY

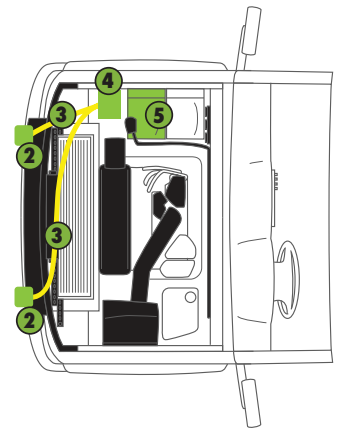

LED 2 X 2" CUBES WITH REMOTE

- Includes 2x lights, mounting brackets, hardware, module, remote and instructions
- Each light includes 9' lead wires
- Ability to run 4+ lights (2 each at 18 amps and 2 amps) with included remote control
- Fast & easy installation – no drilling, no wiring, no switch, no relay

SKU	DESCRIPTION	LUMENS (PER LIGHT)		DIODES	AMP DRAW	BEAM PATTERN	LIGHT TEMP. (K)	CASE QTY
		RAW	EFFECTIVE					
CWL51222	Display Pack	1800	890	4 x 5W	1.1	flood	6200	12

*DENOTES TRILINGUAL PACKAGING **DENOTES BILINGUAL PACKAGING



CWL518 & C3078K



All double rows come with mounting hardware

LED 7" DOUBLE ROW LIGHT BAR

- Includes light, mounting brackets, hardware and instructions
- Dual-chip produces more lumens due to improved technology and a larger surface area
- CWL518 includes 6" lead wire; C3078K includes quick-connecting plug
- Breather valve eliminates fogging inside lens

SKU	DESCRIPTION	LUMENS (PER LIGHT)		DIODES	AMP DRAW	BEAM PATTERN	LIGHT TEMP. (K)	CASE QTY
		RAW	EFFECTIVE					
CWL518*	Display Pack - "Try Me"	1900	2500	12 x 3W	2.4	spot/flood	5700	4
C3078K**	Display Pack - Baja "Try Me"	1900	2500	12 x 3W	2.4	spot/flood	5700	4

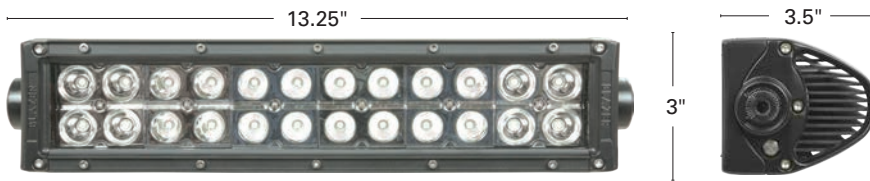

CWL513 & C3068K



LED 13" DOUBLE ROW LIGHT BAR

- Includes light, mounting brackets, hardware and instructions
- Dual-chip produces more lumens due to improved technology and a larger surface area
- Breather valve eliminates condensation and fogging inside the lens

SKU	DESCRIPTION	LUMENS (PER LIGHT)		DIODES	AMP DRAW	BEAM PATTERN	LIGHT TEMP. (K)	CASE QTY
		RAW	EFFECTIVE					
CWL513*	Display Pack - "Try Me"	6700	3700	24 x 3W	4.5	spot/flood	6000	2
C3068K**	Display Pack - Baja "Try Me"	6700	3700	24 x 3W	4.5	spot/flood	6000	2



6" CWL630 on 7" Double Row Light Bar

2 PK LIGHT COVERS

- Easy to snap on and off 6" and 8" segments
- Fits most double row light bars
- Polycarbonate lens – durable and shatter proof. Protects lens when not in use
- CWL630 amber lens improves visibility in fog or snow
- CWL631 black lens covers satisfies regulations in most states/providences (check local laws)

SKU	DESCRIPTION	CASE QTY
CWL630*	Display Pack - amber	12
CWL631*	Display Pack - black	12

*DENOTES TRILINGUAL PACKAGING **DENOTES BILINGUAL PACKAGING

OFF-ROAD LIGHTING & ACCESSORIES

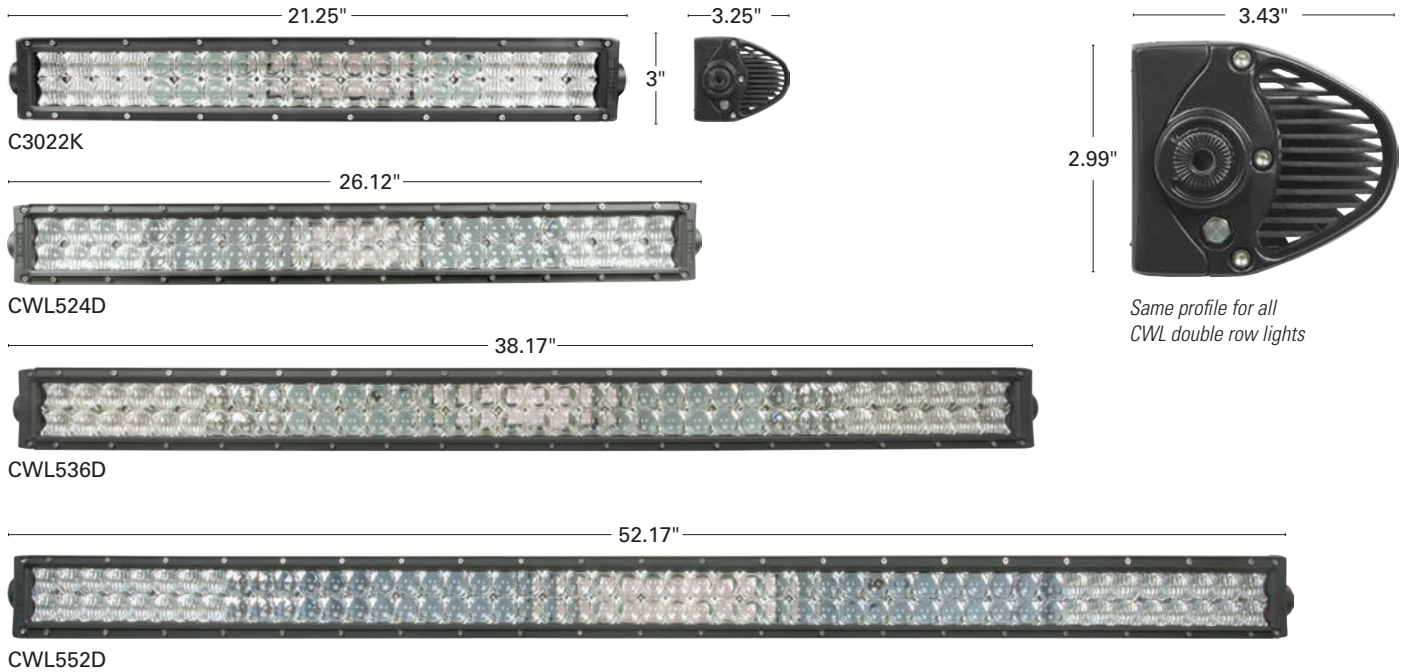

Same profile for all CWL double row lights

LED 22", 24", 36" AND 50" DOUBLE ROW LIGHT BARS

- Includes light, mounting brackets, hardware and instructions
- Light includes quick connecting plug
- 4D optic design maximizes LUX
- Breather valve eliminates condensation and fogging inside the lens
- Vent fins dissipate heat quickly

SKU	DESCRIPTION	LUMENS (PER LIGHT)		DIODES	AMP DRAW	BEAM PATTERN	LIGHT TEMP. (K)	CASE QTY
		RAW	EFFECTIVE					
C3022K**	Display Pack	9600	7400	40 x 3W	6.6	spot/flood	6000	2
CWL524D*	Display Pack	9600	8369	48 x 3W	8.3	spot/flood	6000	2
CWL536D*	Display Pack	14400	11112	72 x 3W	12.7	spot/flood	6000	2
CWL552D*	Display Pack	20000	13489	100 x 3W	17.6	spot/flood	6000	2

10 PK NOISE REDUCING INSERTS

- PVC inserts reduce vibration noise caused by wind, road and terrain
- For Blazer® branded double row LED light bars 22" and above

SKU	DESCRIPTION	CASE QTY
CWL627*	Display Pack	12

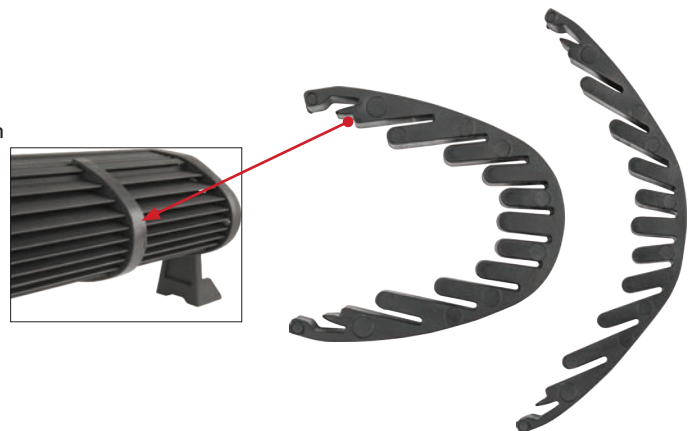

*DENOTES TRILINGUAL PACKAGING **DENOTES BILINGUAL PACKAGING

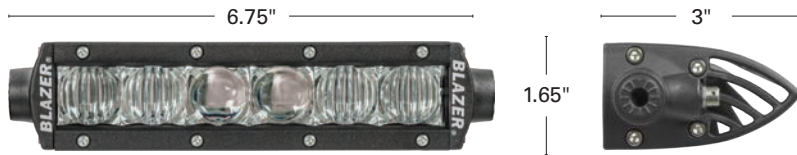

CWL118



All single rows come with mounting hardware

LED 7" SINGLE ROW LIGHT BAR

- Includes light, mounting brackets, hardware and instructions
- 4D optic design maximizes LUX
- Light includes quick connecting plug
- Breather valve eliminates condensation and fogging inside the lens

SKU	DESCRIPTION	LUMENS (PER LIGHT)		DIODES	AMP DRAW	BEAM PATTERN	LIGHT TEMP. (K)	CASE QTY
		RAW	EFFECTIVE					
CWL118*	Display Pack	1200	780	6 x 3W	0.9	spot/flood	6000	4

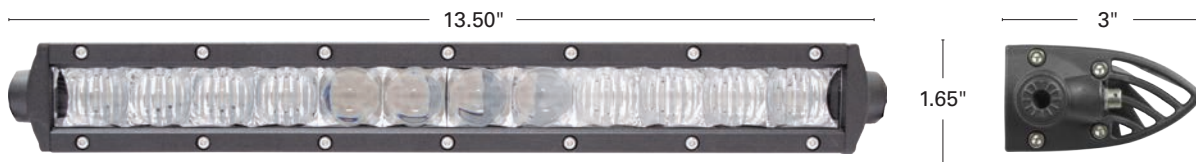

CWL113

LED 13" SINGLE ROW LIGHT BAR

- Includes light, mounting brackets, hardware and instructions
- 4D optic design maximizes LUX
- Light includes quick connecting plug
- Breather valve eliminates condensation and fogging inside the lens

SKU	DESCRIPTION	LUMENS (PER LIGHT)		DIODES	AMP DRAW	BEAM PATTERN	LIGHT TEMP. (K)	CASE QTY
		RAW	EFFECTIVE					
CWL113*	Display Pack	2400	1510	12 x 3W	1.8	spot/flood	6000	2



4D optic design maximizes LUX

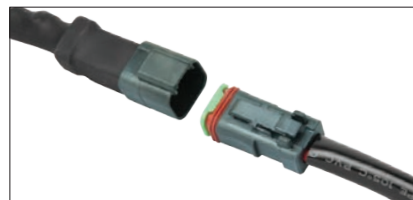

Lights include quick connecting plug



CWL118 with included adjustable mounting hardware

*DENOTES TRILINGUAL PACKAGING **DENOTES BILINGUAL PACKAGING

OFF-ROAD LIGHTING & ACCESSORIES

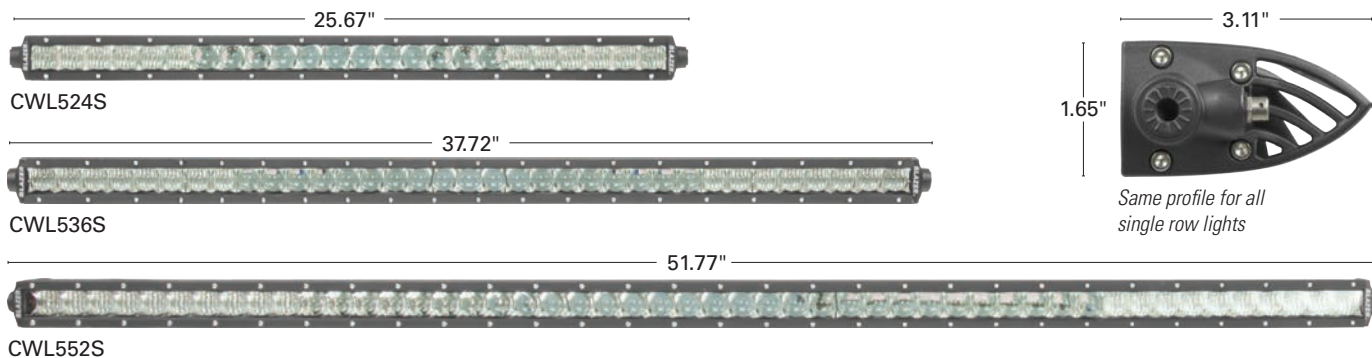

LED 24", 36" & 50" SINGLE ROW LIGHT BARS

- Includes light, mounting brackets, hardware and instructions
- Light includes quick connecting plug
- 4D optic design maximizes LUX
- Breather valve eliminates condensation and fogging inside the lens
- Vent fins dissipate heat quickly

SKU	DESCRIPTION	LUMENS (PER LIGHT)		DIODES	AMP DRAW	BEAM PATTERN	LIGHT TEMP. (K)	CASE QTY
		RAW	EFFECTIVE					
CWL524S*	Display Pack	4800	4033	24 x 3W	4.5	spot/flood	6000	4
CWL536S*	Display Pack	7200	5974	36 x 3W	6.6	spot/flood	6000	4
CWL552S*	Display Pack	10000	6790	50 x 3W	8.4	spot/flood	6000	4

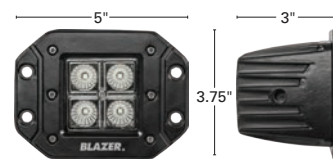

LED 2" CUBE

- Includes light, mounting brackets, hardware and instructions
- Light includes 6" lead wire
- Compact size and shape allows for the light to fit almost anywhere - Perfect for ATVs, Jeeps, golf carts, pickup trucks, riding lawn mowers, boats, snowmobiles and more
- C3071K, C3073KFM and C3073K have quick connecting plugs

SKU	DESCRIPTION	LUMENS (PER LIGHT)		DIODES	AMP DRAW	BEAM PATTERN	LIGHT TEMP. (K)	CASE QTY
		RAW	EFFECTIVE					
CWL511*	Display Pack - "Try Me"	1230	980	4 x 5W	1.34	spot	6200	8
C3073K**	Display Pack - Baja "Try Me"	1320	1056	4 x 5W	0.54	spot	6200	8
CWL512	Display Pack - "Try Me"	1920	880	4 x 5W	1.5	flood	6200	8
C3072K**	Display Pack - Baja "Try Me"	1920	880	4 x 5W	1.5	flood	6200	8
C3071K**	Display Pack - Baja "Try Me" Spot + daytime running light	2000	1530	4 x 5W	1.5	spot	6500	8
C3073KFM**	Display Pack - Baja "Try Me" Flush mount light	750	600	4 x 3W	1.34	flood	6500	12

*DENOTES TRILINGUAL PACKAGING **DENOTES BILINGUAL PACKAGING

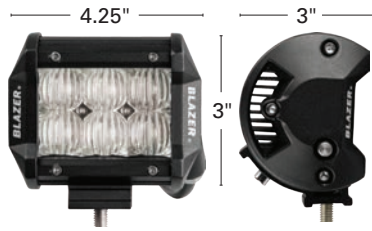

LED 4" DOUBLE ROW LIGHT BAR

- Includes light, mounting bracket, hardware and instructions
- 4D optic design maximizes LUX
- CWL514 includes 6" lead wire; C3074K includes quick connecting plug
- Compact size and shape allows for the light to fit almost anywhere - Perfect for ATVs, Jeeps, golf carts, pickup trucks, riding lawn mowers, boats, snowmobiles and more

SKU	DESCRIPTION	LUMENS (PER LIGHT)		DIODES	AMP DRAW	BEAM PATTERN	LIGHT TEMP. (K)	CASE QTY
		RAW	EFFECTIVE					
CWL514*	Display Pack - "Try Me"	1200	740	6 x 3W	1.75	flood	6200	4
C3074K**	Display Pack - Baja "Try Me"	1200	740	6 x 3W	1.75	flood	6200	4



LED 5" X 2" RECTANGULAR WORK LIGHT

- Includes light, mounting bracket, hardware and instructions
- Light includes 6" lead wire
- Compact size and shape allows for the light to fit almost anywhere - Perfect for ATVs, Jeeps, golf carts, pickup trucks, riding lawn mowers, boats, snowmobiles and more
- Great for work or back-up light

SKU	DESCRIPTION	LUMENS (PER LIGHT)		DIODES	AMP DRAW	BEAM PATTERN	LIGHT TEMP. (K)	CASE QTY
		RAW	EFFECTIVE					
CWL509*	Display Pack - "Try Me"	2000	950	4 x 5W	1.65	flood	6500	8
C3079K**	Display Pack - Baja "Try Me"	2000	950	4 x 5W	1.65	flood	6500	8
C3079TW*	Display Pack - Baja "Try Me" 2 Pk clamshell	2000	950	4 x 5W	1.65	flood	6500	6



LED 4" ROUND UTILITY LIGHT

- Includes light, mounting bracket, hardware and instructions
- Light includes 6" lead wire
- Powerful 40 Watt light projects a narrow beam to maximize distance visibility
- Vent fins dissipate heat quickly

SKU	DESCRIPTION	LUMENS (PER LIGHT)		DIODES	AMP DRAW	BEAM PATTERN	LIGHT TEMP. (K)	CASE QTY
		RAW	EFFECTIVE					
CWL510*	Display Pack - "Try Me"	3500	2500	4 x 10W	3	spot	5500	4
C3080K**	Display Pack - Baja "Try Me"	3500	2500	4 x 10W	3	spot	5500	4



LED 4PK WHITE ROCK LIGHTS

- Includes 4 lights, module, 8 grommets, hardware and instructions
- Lights include waterproof quick connecting plugs
- Off-road applications - ATV/UTCs, Trucks, SUVs, Boats and more
- High-impact polycarbonate lens and housing
- 8 grommets included: 4 for installing onto flat surfaces and 4 for installing on curved surfaces

SKU	DESCRIPTION	DIODES	AMP DRAW	LIGHT TEMP. (K)	CASE QTY
CWL515*	Display Pack	9 x 1W	1.34	6000-6500	12

*DENOTES TRILINGUAL PACKAGING **DENOTES BILINGUAL PACKAGING

WIRELESS MANAGEMENT SYSTEM - 4-CHANNEL

- Includes module and remote
- Remote control operates 4+ lights (2 ea. at 18 and 2 amps)
- Easy installation - no drilling through firewall or adding switches to dash
- Patent-pending sleep mode automatically turns off after 48 hrs. preventing damage to the lights and battery
- Runs two 50" double row LED light bars at the same time



SKU	DESCRIPTION	CASE QTY
CWL622*	Display Pack	12

WIRELESS MANAGEMENT SYSTEM - 8-CHANNEL

- Includes module and remote
- Remote control operates 8+ lights (2 ea. at 20, 5, 3.5 and 1.5 amps)
- Easy installation - no drilling through firewall or adding switches to dash
- Patent-pending sleep mode automatically turns off after 48 hrs. preventing damage to the lights and battery
- Remote control range up to 100'



SKU	DESCRIPTION	CASE QTY
C3050K**	Display Pack - "Try Me"	12

QUICK CONNECT WIRING HARNESS

- Harness includes quick-connecting plug, 40 amp relay, 30 amp fuse and round toggle switch
- 1 and 2-light wiring harnesses are designed for lighting systems under 200 Watts. Heavy-duty wiring harness (CWL620) is designed for systems 200 W and over.
- 9', 16 gauge wire
- Quick-connecting plugs are water resistant and easy to install



SKU	DESCRIPTION	CASE QTY
CWL610*	Display Pack - 1 light	12
C3010K**	Display Pack - Baja 1 light	12
CWL615*	Display Pack - 2 light	12
C3015K*	Display Pack - Baja 2 light	12
CWL620*	Display Pack - 1 Heavy-duty light - designed for CWL552D	12

ROUND ON/OFF SWITCH

- Fits in 3/4" diameter hole
- Illuminated switch lights red when on

SKU	DESCRIPTION	CASE QTY
CWL624*	Display Pack	12



*DENOTES TRILINGUAL PACKAGING **DENOTES BILINGUAL PACKAGING



QUICK-CONNECT PLUG SET

- Includes male and female plugs with 6" leads
- Water resistant and easy to install
- Connect to light, wiring and/or harness

SKU	DESCRIPTION	CASE QTY
CWL625*	Display Pack	12

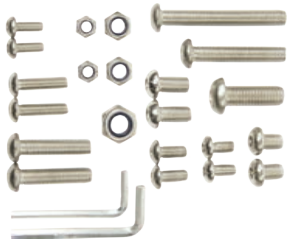

24 PC. THEFT PREVENTION HARDWARE

- Kit includes 2 allen wrenches, 5 lock nuts and 17 various sized screws
- Fits Blazer® light bars
- Unique bolt head deters theft - Standard wrenches or screwdrivers will not remove light

SKU	DESCRIPTION	CASE QTY
CWL626*	Display Pack	12



ROUND MOUNTING BRACKETS

- Designed for mounting a single light or light bar on round or angled bars or frames
- Powder coated, durable steel frame for long lasting use
- Includes bracket, mounting hardware and padding to protect the mounting surface
- Mount can be adjusted and rotated 360 degrees to fit height or width requirements

SKU	DESCRIPTION	CASE QTY
CWL636*	Display Pack - 2" diameter	12
CWL637*	Display Pack - 1.75" diameter	12
CWL638*	Display Pack - 1.5" diameter	12



UNIVERSAL LICENSE PLATE BRACKET

- Designed to use the holes that USA and Canadian license plates fit into (license plate will attach to the bracket, as well)
- Powder coated, durable steel frame for long lasting use
- Fits stud, post and side mounting brackets – fits all Blazer® lights 13" and under
- Bracket can be used on bumper, racks and other locations. Great for cameras, too.

SKU	DESCRIPTION	CASE QTY
CWL692*	Display Pack	6

*DENOTES TRILINGUAL PACKAGING **DENOTES BILINGUAL PACKAGING

TRACTOR/WORK



Featuring the C8005W

- Heavy-duty lights designed for agricultural and industrial use
- Lights are available with spot, flood and trapezoid beam patterns
- LED and halogen options available

5 7/8" ROUND UTILITY LIGHT PAR 36

- Includes light, mounting bracket and hardware
- Stud mount installation
- Shock proof rubber housing and glass lens
- Replaceable #4411-1 halogen bulb
- Current draw: 3.5 Amps

SKU	DESCRIPTION	BEAM PATTERN	CASE QTY
C123	Display Pack - 12V	trapezoid	24
C125	Display Pack - 6V	trapezoid	24

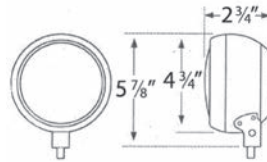

5 5/16" HEAVY-DUTY ROUND UTILITY LIGHT PAR 36

- Includes light, mounting bracket and hardware
- Stud mount installation
- Shock proof steel housing and glass lens
- Replaceable #4411-1 halogen bulb
- Current draw: 3.5 Amps

SKU	DESCRIPTION	BEAM PATTERN	CASE QTY
C223	Display Pack - 12V	trapezoid	24
C225	Display Pack - 6V	trapezoid	24

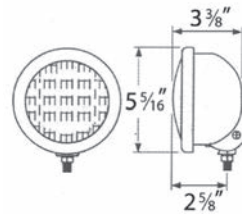

6 7/8" X 4 1/8" RECTANGULAR UTILITY LIGHT

- Includes light, mounting bracket and hardware
- Stud mount installation
- Corrosion resistant molded housing and grill
- Replaceable H3-55W halogen bulb
- Current draw: 5.0 Amps

SKU	DESCRIPTION	BEAM PATTERN	CASE QTY
C8005W	Display Pack	trapezoid	24
C8006W	Display Pack	spot	24
C8007W	Display Pack	flood	24

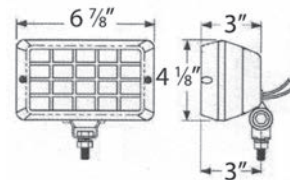

C8005W



C8006W



C8007W

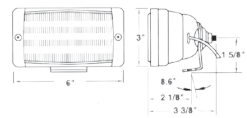

6" X 3" REAR MOUNT TRACTOR LIGHT

- Includes light, mounting bracket and hardware
- Surface mount installation
- Corrosion resistant molded housing
- Replaceable 55W halogen bulb
- Current draw: 5.0 Amps

SKU	DESCRIPTION	BEAM PATTERN	CASE QTY
C8010	Display Pack	flood	24
C8011	Display Pack	trapezoid	24

ATV SPOT LIGHT

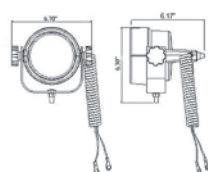

- Includes light with on/off switch, 10' power cord, mounting bracket and zip ties
- Adjustable - rotates 360 degrees horizontally and 90 degrees vertically
- Black ABS plastic housing and polycarbonate lens provide protection against the elements
- Light detaches for handheld use
- Current draw: 3.0 Amps

SKU	DESCRIPTION	BEAM PATTERN	CASE QTY
C8014	Display Pack	spot	6

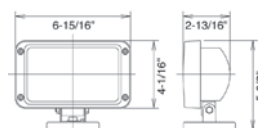

7" X 4" RECTANGULAR HEAVY-DUTY MAGNETIC WORK LIGHT 12V PAR 36

- 20' power cord includes 12 V plug
- Pivoting head - moves side to side and up and down
- Non-scratch, heavy-duty magnetic base for secure mount
- Replaceable 55W halogen bulb
- Current draw: 5.0 Amps

SKU	DESCRIPTION	BEAM PATTERN	CASE QTY
CWL235	Display Pack	flood	16

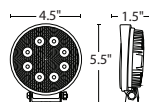

LED 4 1/2" ROUND UTILITY LIGHT

- Powerful, 3-Watt LEDs equivalent to 930 effective / 1,560 raw lumens
- Die cast aluminum housing and high-impact polycarbonate lens
- IP-67 rating against dust and water
- Includes adjustable mounting bracket and hardware
- Current draw: 1.3 Amps

SKU	DESCRIPTION	BEAM PATTERN	CASE QTY
CWL503	Display Pack - clamshell	flood	12
CWL504	Display Pack - box	flood	12

LED 4 1/4" SQUARE UTILITY LIGHT

- Powerful, 3-Watt LEDs equivalent to 930 effective / 1,560 raw lumens
- Die cast aluminum housing and high-impact polycarbonate lens
- IP-67 rating against dust and water
- Includes adjustable mounting bracket and hardware
- Current draw: 1.3 Amps

SKU	DESCRIPTION	BEAM PATTERN	CASE QTY
CWL505	Display Pack - clamshell	flood	12
CWL506	Display Pack - box	flood	12

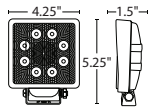

LED 2 3/4" SQUARE UTILITY LIGHT

- 4 powerful, 3-Watt LEDs equivalent to 600 effective / 1,200 raw lumens
- Die cast aluminum housing and high-impact polycarbonate lens
- IP-67 rating against dust and water
- Includes adjustable mounting bracket and hardware
- Current draw: 1.25 Amps

SKU	DESCRIPTION	BEAM PATTERN	CASE QTY
CWL507	Display Pack - clamshell	flood	12

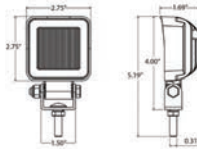

LED 4 1/2" X 2 1/2" RECTANGULAR UTILITY LIGHT

- 6 powerful, 3-Watt LEDs equivalent to 630 effective / 1,200 raw lumens
- Die cast aluminum housing and high-impact polycarbonate lens
- IP-67 rating against dust and water
- Includes adjustable mounting bracket and hardware
- Current draw: 0.9 Amps

SKU	DESCRIPTION	BEAM PATTERN	CASE QTY
CWL508	Display Pack - box	flood	12

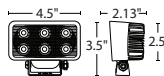

LED 4 1/4" SQUARE MAGNETIC UTILITY LIGHT

- 5 powerful, 5-Watt LEDs equivalent to 1,100 effective / 1,560 raw lumens
- Die cast aluminum housing and high-impact polycarbonate lens
- IP-67 rating against dust and water
- Non-scratch, heavy-duty magnetic base for secure mount and 12' power cord with 12 V plug
- Current draw: 1.37 Amps

SKU	DESCRIPTION	BEAM PATTERN	CASE QTY
CWL535	Display Pack - clamshell	flood	12

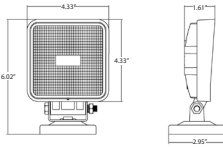

LED 5" X 2" RECTANGULAR WORK LIGHT

- 4 powerful, 5-Watt LEDs equivalent to 950 effective / 2,000 raw lumens
- Die cast aluminum housing and high-impact polycarbonate lens
- IP-67 rating against dust and water
- Includes adjustable mounting bracket and hardware
- Current draw: 1.65 Amps

SKU	DESCRIPTION	BEAM PATTERN	CASE QTY
C129	Display Pack - Clamshell	flood	8

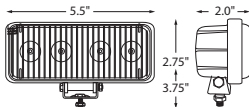

LICENSE/INTERIOR/BACK-UP/UTILITY



Featuring the C398SB

- All Blazer license and back-up lights are DOT approved - Meets FMVSS108 and CMVSS 108 Safety Standards ensuring that you are receiving the safest of products
- Blazer offers LED and incandescent interior/utility lighting options for trailer, RV and truck applications

LED LICENSE LIGHT

- Surface mount installation
- Housing and lens are sonic welded to create a sealed light
- Two-wire design
- Current draw: 0.07 Amps

SKU	DESCRIPTION	CASE QTY
158B	Light only	96
159B	Light with mounting base	96

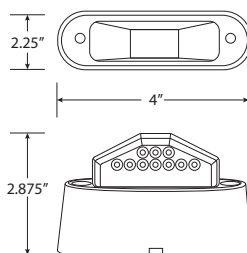

ROUND SNAP-IN LICENSE/UTILITY LIGHT

- Chrome plated light snaps into a 1-1/4" diameter hole
- Single wire design grounds through the mounting hardware
- Replacement bulb #67
- Current draw: 0.6 Amps

SKU	DESCRIPTION	CASE QTY
B160	Display Pack	36
160B	light only	500

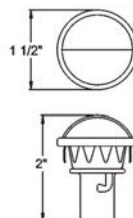

LED SNAP-IN LICENSE/UTILITY LIGHT

- Chrome plated light snaps into a 1-1/4" diameter hole
- Two-wire design
- Offers a bright light that won't give off heat - hooded to reduce glare
- Current draw: 0.04 Amps

SKU	DESCRIPTION	CASE QTY
B165	Display Pack	12

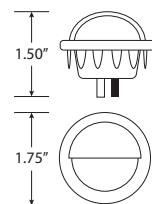

LICENSE/UTILITY LIGHT

- Surface mounts with ear mounts and requires a 1-15/16" diameter hole
- Single wire design grounds through the mounting hardware
- Replacement bulb #67
- Current draw: 0.6 Amps

SKU	DESCRIPTION	CASE QTY
175B	light only	200

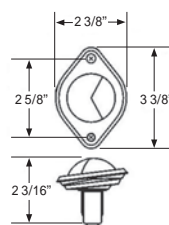

HOODED LICENSE LIGHT

- Surface mount installation
- Single wire design grounds through the mounting hardware
- Replacement bulb #67
- Current draw: 0.6 Amps

SKU	DESCRIPTION	CASE QTY
B149	Display Pack	36

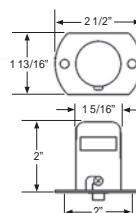

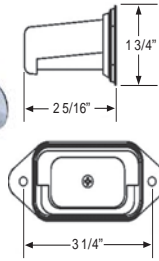

HOODED SURFACE MOUNT LICENSE LIGHT

- Surface mount installation using stainless steel bracket
- Single wire design grounds through the mounting hardware
- Replacement bulb #194
- Current draw: 0.35 Amps

SKU	DESCRIPTION	CASE QTY
174B	light only	100

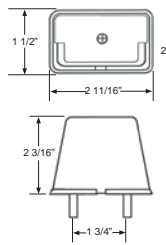

HOODED STUD MOUNT LICENSE LIGHT

- Stud mount installation
- Single wire design grounds through the mounting hardware
- Replacement bulb #194
- Current draw: 0.35 Amps

SKU	DESCRIPTION	CASE QTY
B170	Display Pack	72
170B	light only	200

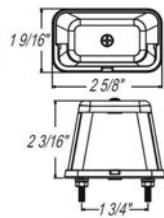

LED HOODED STUD MOUNT LICENSE LIGHT

- Stud mount installation
- Single wire design grounds through the mounting hardware
- Chrome plated housing with clear lens
- Current draw: 0.05 Amps

SKU	DESCRIPTION	CASE QTY
C168	Display Pack	24
169B	light only - 5 diode LED	100

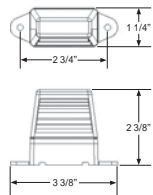

SEALED LICENSE LIGHT

- Surface mount installation
- Accepts industry standard 2-prong plug
- ABS plastic housing and polycarbonate lens
- Current draw: 0.35 Amps

SKU	DESCRIPTION	CASE QTY
176B	light only	200

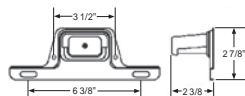

HOODED LICENSE LIGHT WITH STAINLESS STEEL BRACKET

- Surface mount installation
- Two-wire design
- Replacement bulb #194
- Current draw: 0.35 Amps

SKU	DESCRIPTION	CASE QTY
172B	light and black steel license bracket	100

HOODED LICENSE LIGHT

- Surface mount installation
- Two-wire design
- Replacement bulb #194
- Current draw: 0.25 Amps

SKU	DESCRIPTION	CASE QTY
178B	light only	200

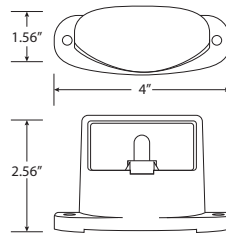

EAR MOUNT HOODED LICENSE/UTILITY LIGHT

- Surface mount installation
- Two-wire design
- Replacement bulb #194
- Current draw: 1.70 Amps

SKU	DESCRIPTION	CASE QTY
B461	Display Pack - light only	72

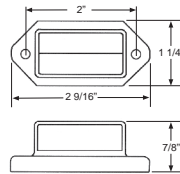

LED EAR MOUNT HOODED LICENSE/UTILITY LIGHT

- Surface mount installation
- Two-wire design
- Polished, chrome-plated housing
- Current draw: 0.06 Amps

SKU	DESCRIPTION	CASE QTY
B168	Display Pack - light only - 2 diode LED	24
168B	light only - 2 diode LED	200

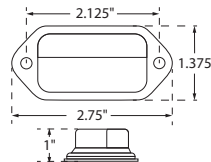

4 1/2" RECTANGULAR INTERIOR AND UTILITY LIGHT WITH ON/OFF BUTTON

- Surface mount installation
- Two-wire design
- Replacement bulb #1156
- Current draw: 1.70 Amps

SKU	DESCRIPTION	CASE QTY
B450C	Display Pack	24

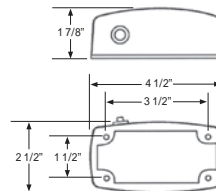

UTILITY/DOME LIGHT WITH ON/OFF SWITCH

- Surface mount installation
- Two-wire design
- Replacement bulb #921
- Current draw: 1.70 Amps

SKU	DESCRIPTION	CASE QTY
396SB	light only	50

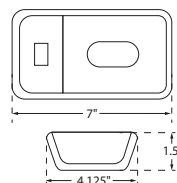

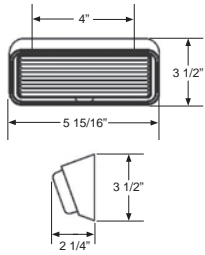

LED RECTANGULAR PORCH/DOME LIGHT WITH ON/OFF SWITCH

- Surface mount installation
- Two-wire design
- 400 lumens - offers a bright light that won't give off heat
- Current draw: 0.36 Amps

SKU	DESCRIPTION	CASE QTY
C393S	Display Pack	12

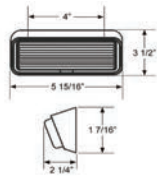

6" RECTANGULAR PORCH/UTILITY LIGHT WITH ON/OFF SWITCH

- Surface mount installation
- Two-wire design
- Replacement bulb #1156
- Current draw: 1.70 Amps

SKU	DESCRIPTION	CASE QTY
B393S	Display Pack	24
T393SB	light only	50

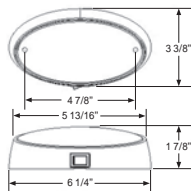

OVAL PORCH/UTILITY LIGHT WITH ON/OFF SWITCH

- Surface mount installation
- Single-wire design
- Replacement bulb #1156
- Current draw: 1.70 Amps

SKU	DESCRIPTION	CASE QTY
394SB	light only	100

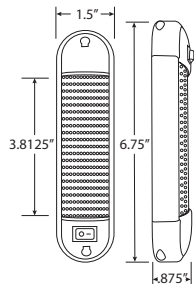

LED INTERIOR LIGHT WITH ON/OFF SWITCH

- Surface mount installation
- Two-wire design
- 140 lumens - offers a bright light that won't give off heat
- Current draw: 0.09 Amps

SKU	DESCRIPTION	CASE QTY
C396S	Display Pack	12

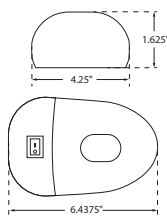

LED DOME LIGHT WITH ON/OFF SWITCH

- Surface mount installation
- Two-wire design
- 6 high-power LEDs
- Current draw: 0.17 Amps

SKU	DESCRIPTION	CASE QTY
398SB	light only	50

LED DOME LIGHT WITH ON/OFF SWITCH

- Surface mount installation
- Two-wire design
- 300 lumens - offers a bright light that won't give off heat
- Current draw: 0.15 Amps

SKU	DESCRIPTION	CASE QTY
C394S	Display Pack	12

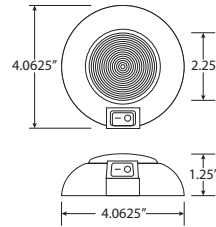

INTERIOR LIGHT WITH ON/OFF SWITCH

- Surface mount installation
- Two-wire design
- Replacement bulb #194
- Current draw: 0.40 Amps

SKU	DESCRIPTION	CASE QTY
B452	Display Pack	72

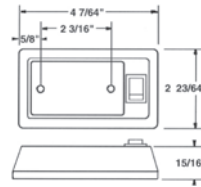

CHROME PLATED DOME LIGHT

- Surface mount installation
- Two-wire design
- Replacement bulb #1156
- Current draw: 1.60 Amps

SKU	DESCRIPTION	CASE QTY
392SB	light only	72

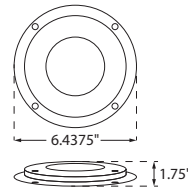

LED TRAILER INTERIOR LIGHT

- Surface mount installation
- Two-wire design
- 400 lumens - offers a bright light that won't give off heat
- Current draw: 0.16 Amps

SKU	DESCRIPTION	CASE QTY
C397S	Display Pack	12

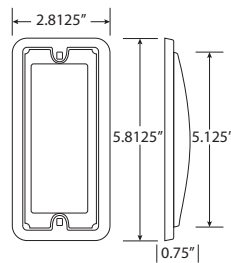

CHROME PLATED BACK-UP LIGHT

- Surface mount installation
- Single wire design grounds through mounting hardware
- Replacement bulb #1156
- Current draw: 1.50 Amps

SKU	DESCRIPTION	CASE QTY
B669BU	Display Pack - light, grommet and plug	24

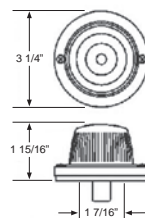

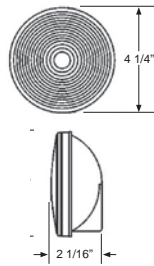

4" ROUND SEALED BACK-UP LIGHT

- Grommet mount installation
- Housing and lens are sonic welded to create a sealed light
- Accepts industry standard 2-prong plug
- Current draw: 2.50 Amps

SKU	DESCRIPTION	CASE QTY
B95C	Display Pack - Light, grommet and plug	12
95BC	light only	100

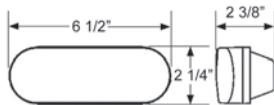

6" OVAL BACK-UP LIGHT

- Grommet mount installation
- Housing and lens are sonic welded to create a sealed light
- Accepts industry standard 2-prong plug
- Current draw: 2.40 Amps

SKU	DESCRIPTION	CASE QTY
B672UK	Display Pack - light, grommet and plug	12

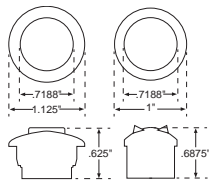

LED 3/4" ROUND UTILITY LIGHT

- Hardwire design prevents lamp-plug failures and corrosion
- Can be used as utility, step well or cabinet lights
- Easily installs into any 3/4" opening
- Current draw: 0.02 Amps

SKU	DESCRIPTION	CASE QTY
C1534BCK	Display Pack - blister pack light with grommet - white	24
C534BCK	Display Pack - polybag light with grommet - white	36
C534CK6	Display Pack - 6 Pk polybag with 6 grommets & 6 chrome flanges - white	12
534BCK	light with grommet - white	400
534BCK2B	light, grommet and bullet connector - white	400
534BBK	light with grommet - blue	400
534BGK	light with grommet - green	400

LED 4-FUNCTION UTILITY LIGHT FOR 7-PRONG HITCHES

- Fits into standard 7-prong hitch pin
- Back-up function: 150 lumens of light will be illuminated whenever the vehicle is put into reverse
- 3rd brake function: Light will illuminate whenever the brake is used
- Work/flashlight function: Light illuminates when switch is turned to the on position. Use while the light is plugged into the 7-way plug or take the light out and use as a flashlight. Flashlight mode requires 3 AAA batteries (not included)
- Current draw: 1.25 Amps



SKU	DESCRIPTION	CASE QTY
C2080	Display Pack	12

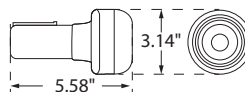

INTERIOR LIGHT WITH ON/OFF SWITCH

- Fits into standard 7-prong hitch pin
- Adds additional visibility to the rear of the vehicle when backing up in low light conditions
- 35 Watt halogen bulb
- Current draw: 2.85 Amps



SKU	DESCRIPTION	CASE QTY
C8020	Display Pack - light only	24

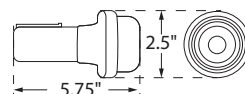

LED 4" ROUND BACK-UP LIGHT

- Grommet mount installation
- Housing and lens are sonic welded to create a sealed light
- Accepts industry standard 3-prong plug
- Current draw: 0.14 Amps

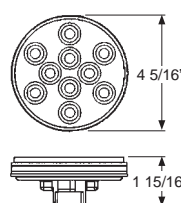

SKU	DESCRIPTION	CASE QTY
542BC	light only	120

LED 6" OVAL BACK-UP LIGHT

- Grommet mount installation
- Housing and lens are sonic welded to create a sealed light
- Accepts industry standard 3-prong plug
- Current draw: 0.14 Amps

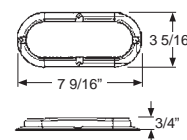

SKU	DESCRIPTION	CASE QTY
561BC	light only	120

REFLECTORS



Featuring the 376RDM

- Blazer® reflector products are weather resistant , provide awareness and are highly visible at night and in inclement weather
- Choose from a wide variety of shapes and sizes with different mounting options
- Reflector staffs are great for marking driveways, parking lots and curbs for snow removal or marking property boundaries

3 1/8" RECTANGULAR SELF-ADHESIVE REFLECTOR

- Permanent mount adhesive back
- Optional mounting holes (screws not included)
- Durable acrylic lens

SKU	DESCRIPTION	COLOR	CASE QTY
B178SAW	Display Pack - 2 pack	amber	36
B178SRW	Display Pack - 2 pack	red	36
T178SA	reflector only	amber	1000
T178SR	reflector only	red	1000

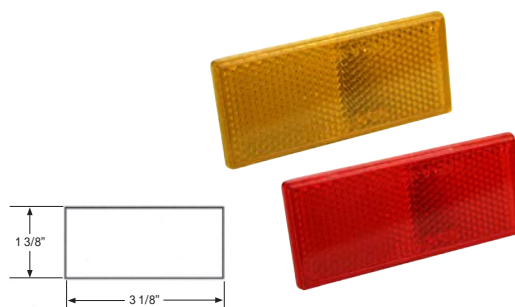

4 3/8" RECTANGULAR SELF-ADHESIVE REFLECTOR

- Permanent mount adhesive back
- Optional mounting holes (screws not included)
- Durable acrylic lens

SKU	DESCRIPTION	COLOR	CASE QTY
188SA	reflector only	amber	500
188SR	reflector only	red	500

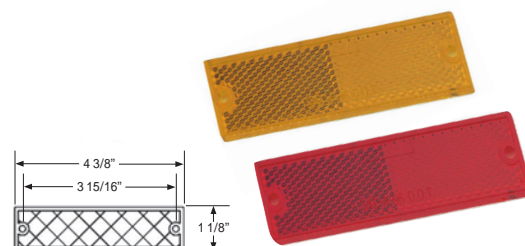

3 1/2" RECTANGULAR SELF-ADHESIVE REFLECTOR

- Chrome plated bezel
- Permanent mount adhesive back
- Durable acrylic lens

SKU	DESCRIPTION	COLOR	CASE QTY
168SA	reflector with chrome bezel	amber	500
168SR	reflector with chrome bezel	red	500

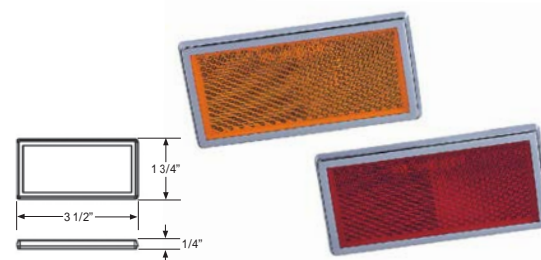

4 3/8" OBLONG SELF-ADHESIVE REFLECTOR

- Permanent mount adhesive back
- Optional mounting holes (screws not included)
- Durable acrylic lens

SKU	DESCRIPTION	COLOR	CASE QTY
B278SAW	Display Pack - 2 pack	amber	36
B278SRW	Display Pack - 2 pack	red	36
T78SA	reflector only	amber	1000
T78SR	reflector only	red	1000

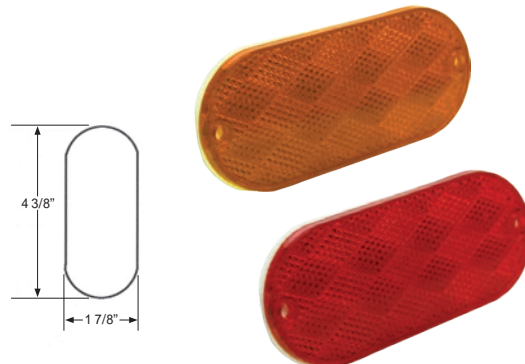

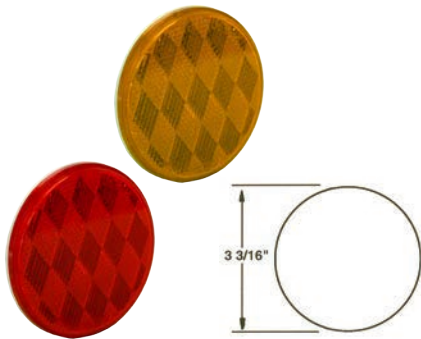

3 3/16" ROUND SELF-ADHESIVE REFLECTOR

- Permanent mount adhesive back
- Durable acrylic lens

SKU	DESCRIPTION	COLOR	CASE QTY
B38SA	Display Pack - 1 Pk Clamshell	amber	72
B38SR	Display Pack - 1 Pk Clamshell	red	72
B38SRW	Display Pack - 2 Pk Card	red	72
T38SA	reflector only	amber	1000
T38SR	reflector only	red	1000

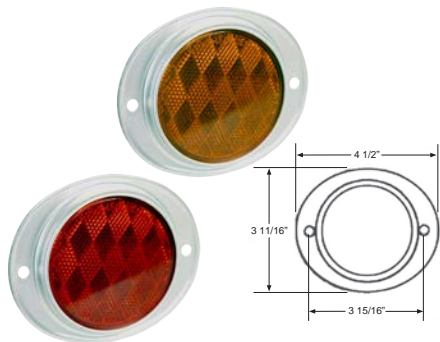

OVAL ALUMINUM REFLECTOR

- Surface mount installation
- Rustproof aluminum housing
- Mounting hardware not included

SKU	DESCRIPTION	COLOR	CASE QTY
B888A	Display Pack	amber	36
B888R	Display Pack	red	36
T888BA	reflector only	amber	500
T888BR	reflector only	red	500

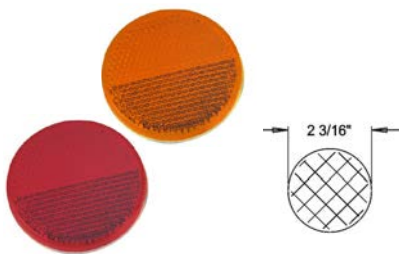

2 3/16" ROUND REFLECTOR

- Permanent mount adhesive back
- Durable acrylic lens

SKU	DESCRIPTION	COLOR	CASE QTY
58SA	reflector only	amber	300
58SR	reflector only	red	300

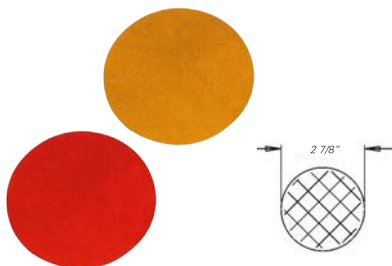

2 7/8" ROUND REFLECTOR

- Permanent mount adhesive back
- Durable acrylic lens

SKU	DESCRIPTION	COLOR	CASE QTY
89BA	reflector only	amber	675
89BR	reflector only	red	675

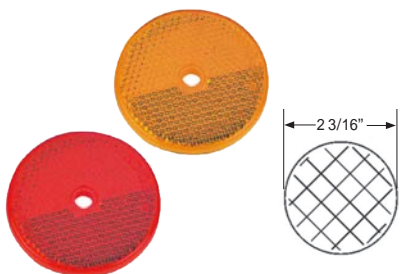

2 3/16" ROUND REFLECTOR

- Surface mount installation - mounts with screw through center hole
- Durable acrylic lens
- Mounting hardware not included

SKU	DESCRIPTION	COLOR	CASE QTY
58BA	reflector only	amber	1000
58BR	reflector only	red	1000

3 3/16" ROUND REFLECTOR

- Surface mount installation - mounts with screw through center hole
- Durable acrylic lens
- Mounting hardware (not included)

SKU	DESCRIPTION	COLOR	CASE QTY
68BA	reflector only	amber	500
68BR	reflector only	red	500

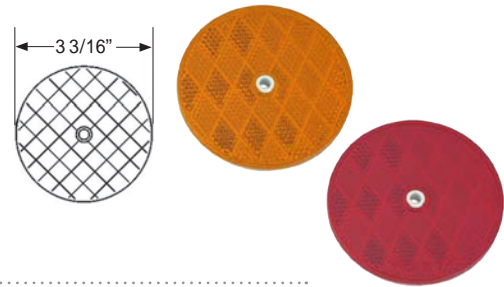

1" X 12" CONSPICUITY REFLECTOR

- DOT and SAE compliant for reflective marking
- Surface mount using the adhesive backing or on 3-15/16" centers with two screws (screws not included)
- Hermetically sealed to keep out moisture and dirt
- Will not wrinkle, rip or bubble like tape

SKU	DESCRIPTION	COLOR	CASE QTY
T280C	Display Pack - UPC open stock	clear	12
T280R	Display Pack - UPC open stock	red	12
V280C	Display Pack - 4 Pk Shrink wrap	clear	12
V280R	Display Pack - 4 Pk Shrink wrap	red	12

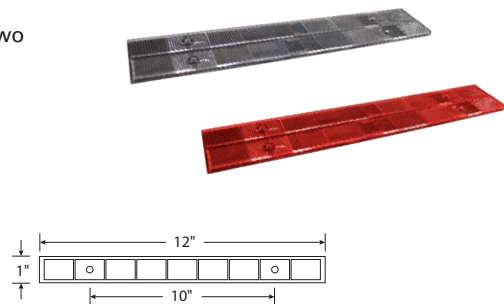

RECTANGULAR SELF-ADHESIVE REFLECTOR

- DOT and SAE compliant for reflective marking
- Permanent mount adhesive back
- Hermetically sealed to keep out moisture and dirt

SKU	DESCRIPTION	COLOR	CASE QTY
88BA	reflector only - 2-3/4" x 1-3/4"	amber	4500
88BR	reflector only - 2-3/4" x 1-3/4"	red	4500
90BA	reflector only - 4-5/16" x 1-11/16"	amber	750
90BR	reflector only - 4-5/16" x 1-11/16"	red	750



3 PK. COLLAPSIBLE REFLECTIVE TRIANGLES WITH PLASTIC CASE

- Meets FMVSS125 DOT requirements
- Ideal for roadside safety when changing a tire or performing under-the-hood maintenance
- Weighted base - will not blow away or knock down from passing vehicles
- Easy to set up and fold down

SKU	DESCRIPTION	COLOR	CASE QTY
7500	Display Pack - 3 Pk with storage case	orange/red	4





WHITE/RED CONSPICUITY TAPE

- FMVSS108 compliant
- Industrial-strength adhesive for mounting on flat or curved surfaces
- 4X greater reflectivity, higher visibility at long range and tougher durability than conventional conspicuity reflectors
- Each red/white pattern measures 18" (11" red and 7" white) x 2"

SKU	DESCRIPTION	COLOR	CASE QTY
B280RW	Display Pack - 4 Pk polybag 18" strips	red/white	8
C285RW	Display Pack - 30' roll carded	red/white	4
B38SA	Display Pack - 1 Pk Clamshell	amber	72
B38SR	Display Pack - 1 Pk Clamshell	red	72
B38SRW	Display Pack - 2 Pk Card	red	72
T38SA	reflector only	amber	1000
T38SR	reflector only	red	1000

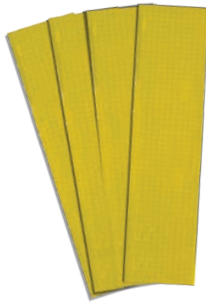

YELLOW CONSPICUITY TAPE - 4 PK

- Designed for agricultural equipment on highways
- Industrial-strength adhesive for mounting on flat or curved surfaces
- Meet and exceed the requirements for ASTM D4956-13, ANSI/ASAE S276.7 & S279.17
- Each strip measures 9" x 2"

SKU	DESCRIPTION	COLOR	CASE QTY
B280A	Display Pack	yellow	24



36" TWO-SIDED ROUND REFLECTIVE DRIVEWAY MARKER

- 2x 3-1/4" round reflectors sealed in plastic housing
- 36" galvanized rod is 3/16" round and corrosion resistant
- Highly visible at night and in inclement weather

SKU	DESCRIPTION	COLOR	CASE QTY
376RDM	Single staff with UPC	red	8
376RDM-8	8 Pk box	red	1
376RDM-24	24 Pk box	red	1
376BDM	Single staff with UPC	blue	8
376BDM-8	8 Pk box	blue	1
376BDM-24	24 Pk box	blue	1



48" TWO-SIDED RECTANGULAR DRIVEWAY MARKER

- 2x rectangular reflectors sealed in plastic housing
- 48" durable fiberglass pole is 3/8" round and corrosion resistant
- Features a pointed tip for easy installation

SKU	DESCRIPTION	COLOR	CASE QTY
379RDM	Single staff with UPC	red	72
379RDM-24	24 Pk box	red	1

48" REFLECTIVE FIBERGLASS DRIVEWAY MARKER

- 48" durable fiberglass pole is 1/4" round and corrosion resistant
- Top 10" is wrapped with high visibility reflective tape and has a protective cap on top to prevent splintering when tapping into the ground
- Features a pointed tip for easy installation
- 372ODM has a 72" pole

SKU	DESCRIPTION	COLOR	CASE QTY
381ODM	Single staff with UPC	orange	72
381ODM-4	Display Pack - 4 Pk carded	orange	8
381ODM-24	24 Pk box	orange	1
381ODM-72	72 Pk box	orange	1
372ODM	Single 72" staff with UPC	orange	72
372ODM-24	72" staff 24 Pk box	orange	72
381YDM	Single staff with UPC	yellow	72
381YDM-24	24 Pk box	yellow	1
381YDM-72	72 Pk box	yellow	1

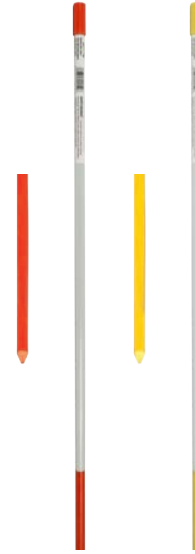

72" TWO-SIDED ROUND REFLECTIVE DRIVEWAY MARKER

- 2x 3-1/4" round reflectors sealed in plastic housing
- 72" durable yellow fiberglass pole is 3/8" round and corrosion resistant
- Red foot peg ensures easy installation and keeps unit secure in ground - resists spinning due to wind
- Great for marking driveways for snow removal

SKU	DESCRIPTION	COLOR	CASE QTY
384CDM	Single staff with UPC	clear	72
384CDM-24	24 Pk box	clear	1



48" TWO-SIDED ROUND DRIVEWAY MARKER

- 2x 3-1/4" round reflectors sealed in plastic housing
- 48" durable fiberglass pole is 1/4" round and corrosion resistant
- Features a pointed tip for easy installation

SKU	DESCRIPTION	COLOR	CASE QTY
382RDM	Single staff with UPC	red	72
382RDM-24	24 Pk box	red	1



42" FOUR-SIDED FANCY DRIVEWAY MARKER

- Topped with 4-sided rectangular reflectors
- 42" PVC pole is 1/2" round and corrosion resistant
- Black foot peg ensures easy installation and keeps unit secure in ground - resists spinning due to wind
- Great for dressing up any driveway or residence

SKU	DESCRIPTION	COLOR	CASE QTY
377RDM	Single staff with UPC	red	48
377RDM-24	24 Pk box	red	1



REPLACEMENT LENSES

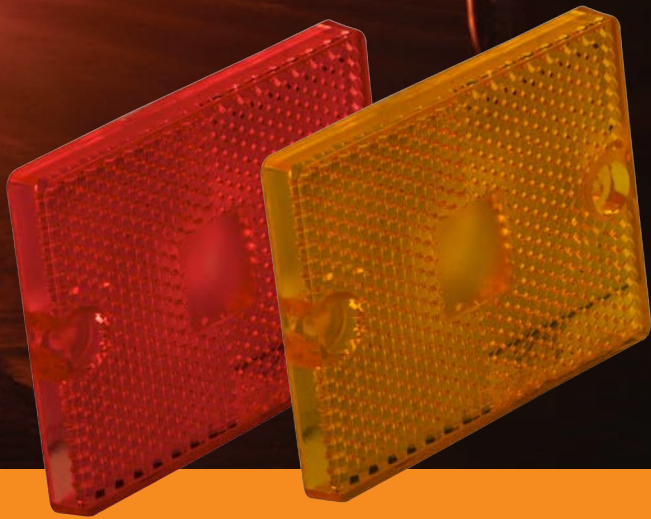

Featuring the B9423R / B9423A

- Blazer® provides a variety of replacement lenses for clearance and side markers, stop/tail/turn lights and back-up lights.
- High quality replacement lenses are available in retail and bulk configurations

LENS FOR 83 / 93 / C6423 / 83QB / 93QB

- Stop/tail/turn lens

SKU	DESCRIPTION	COLOR	CASE QTY
B983	Display Pack - lens only	red	36
T983B	lens only	red	300



LENS FOR B99SW

- Stop/tail/turn lens

SKU	DESCRIPTION	COLOR	CASE QTY
B999R	Display Pack - lens only	red	36



LENS FOR 567

SKU	DESCRIPTION	COLOR	CASE QTY
B9106A	Display Pack - lens only	amber	36
B9106R	Display Pack - lens only	red	36



LENS FOR 430 / 3552

- Stop/tail/turn lens

SKU	DESCRIPTION	COLOR	CASE QTY
B9216R	Display Pack - lens only	red	36



LENS FOR C6423

SKU	DESCRIPTION	COLOR	CASE QTY
B9423K	Display Pack - B83, B93, front and side marker lenses	amber/ red	36

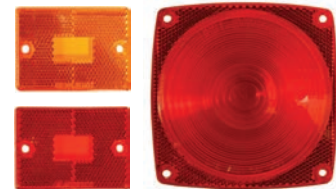

LENS FOR 423A / 423R

SKU	DESCRIPTION	COLOR	CASE QTY
B9423A	Display Pack - lens only	amber	36
B9423R	Display Pack - lens only	red	36

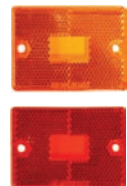

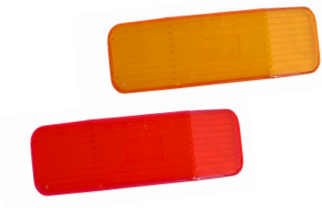

LENS FOR B427

SKU	DESCRIPTION	COLOR	CASE QTY
B9427A	Display Pack - lens only	amber	36
B9427R	Display Pack - lens only	red	36



LENS FOR 444

SKU	DESCRIPTION	COLOR	CASE QTY
B9444A	Display Pack - lens only	amber	36
B9444R	Display Pack - lens only	red	36



LENS FOR 55UW / 55SW

SKU	DESCRIPTION	COLOR	CASE QTY
B9460R	Display Pack - lens only	red	24



LENS FOR 486

SKU	DESCRIPTION	COLOR	CASE QTY
B9486A	Display Pack - lens only	amber	36
B9486R	Display Pack - lens only	red	36



LENS FOR 487

SKU	DESCRIPTION	COLOR	CASE QTY
B9487A	Display Pack - lens only	amber	36
B9487R	Display Pack - lens only	red	36

LENS FOR 482TW2

SKU	DESCRIPTION	COLOR	CASE QTY
B9610A	Display Pack - lens only	amber	36
B9610R	Display Pack - lens only	red	36



LENS FOR 481

SKU	DESCRIPTION	COLOR	CASE QTY
91327BA	lens only	amber	50
91327BR	lens only	red	50



LENS FOR 827

SKU	DESCRIPTION	COLOR	CASE QTY
9827A	lens only	amber	50
9827R	LENS ONLY	red	50



LENS FOR 484

SKU	DESCRIPTION	COLOR	CASE QTY
B9899A	Display Pack - lens only	amber	36
B9899R	Display Pack - lens only	red	36



LENS FOR 670

SKU	DESCRIPTION	COLOR	CASE QTY
91101C	lens only	clear	50



BRACKETS/PLUGS/GROMMETS



Featuring the 95233

- Blazer® offers grommets, plugs and brackets that are designed to meet the functional and decorative needs of our customers
- Full line of plugs for side and clearance, utility stop/tail/turn, park/turn and warning lighting
- A variety of grommets and brackets to install lights onto your vehicle or trailer

BRACKETS/PLUGS/GROMMETS

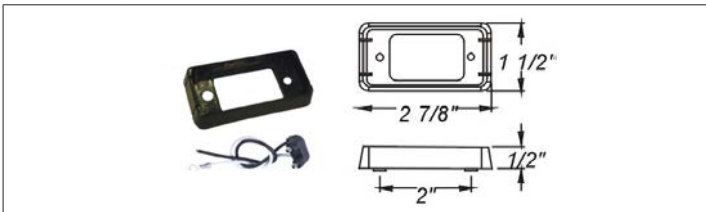

PART #	CASE QTY	DESCRIPTION
92536BK	50	Mounting bracket kit - black

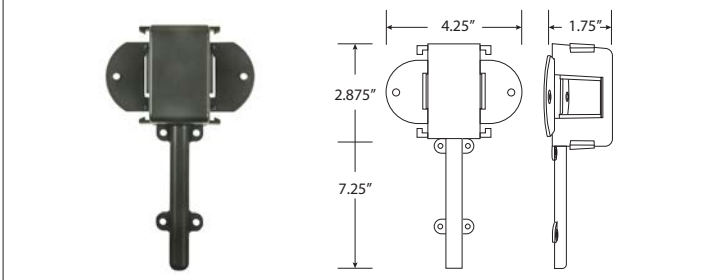

PART #	CASE QTY	DESCRIPTION
93721	50	Fender bracket kit - black

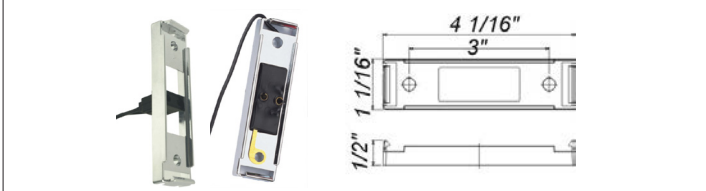

PART #	CASE QTY	DESCRIPTION
92232C	500	Mounting bracket - chrome
92232B	500	Mounting bracket - black
92232CK	500	Mounting bracket kit - chrome
92232BK	500	Mounting bracket kit - black
B92232K	24	Display Pack - bracket and plug



PART #	CASE QTY	DESCRIPTION
92129C	500	Mounting bracket - chrome



PART #	CASE QTY	DESCRIPTION
B192	48	Universal plastic license bracket

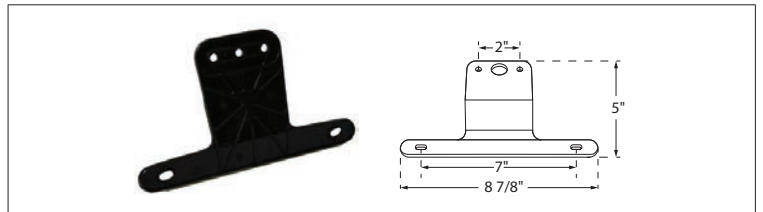

PART #	CASE QTY	DESCRIPTION
T182B	300	Universal plastic license bracket

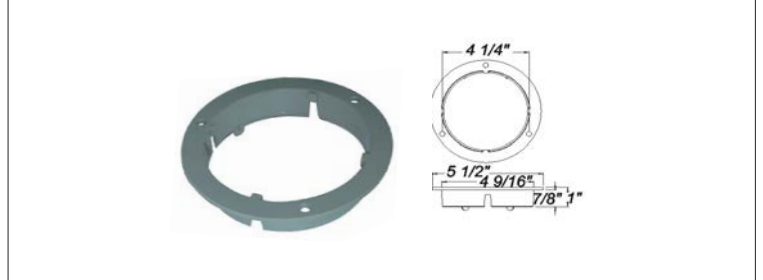

PART #	CASE QTY	DESCRIPTION
92227-2C	100	4" Snap-in bracket - chrome
96101	600	Retainer ring

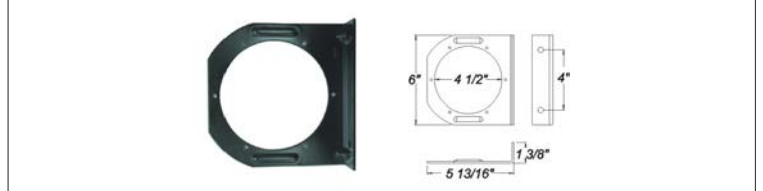



PART #	CASE QTY	DESCRIPTION
92227	50	Steel mounting for 4" round lights

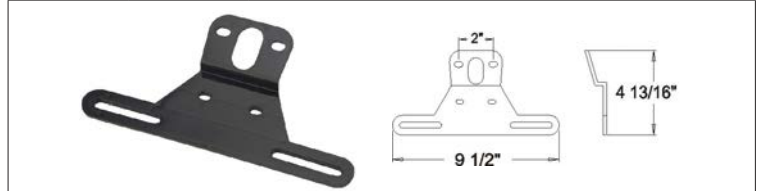

PART #	CASE QTY	DESCRIPTION
B92233	50	Display Pack
92233	50	Steel mounting bracket for 6" oval lights

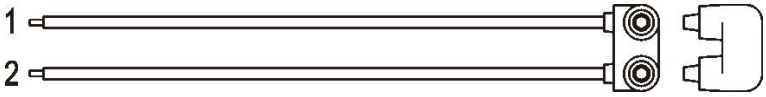
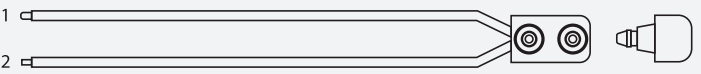
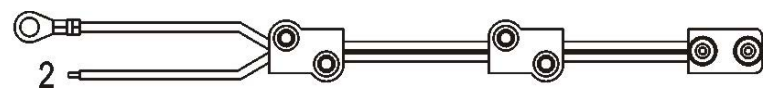
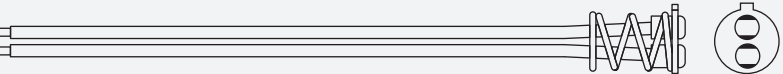
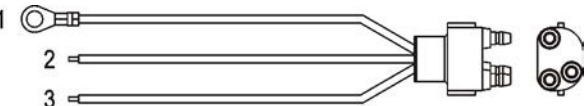
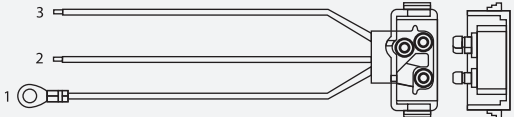
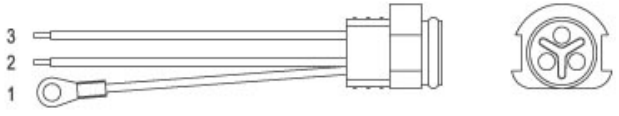

PART #	CASE QTY	DESCRIPTION
92204	250	License plate bracket

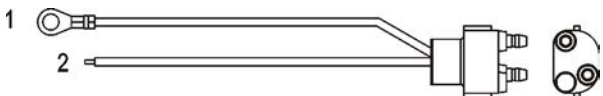
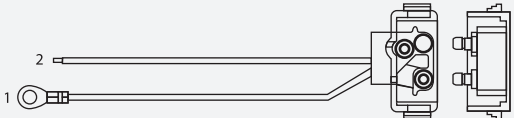
TECHNICAL DRAWING	PART #	CASE QTY	DESCRIPTION
	93875	500	Side-by-side clearance marker plug
	B938751	36	Display Pack - plug
	938751	500	Clearance marker plug
	93203	500	ID bar harness
	97881	2000	Pigtail, 2 wire
	B93874	36	Display Pack - plug
	93874	500	Straight stop/tail/turn plug
	93876	500	90° Stop/tail/turn plug
	93029	500	Stop/tail/turn plug
	93549	500	Waterproof stop/tail/turn plug
	938741	500	Straight stop and turn plug
	938761	500	90° Stop and turn plug

BRACKETS/PLUGS/GROMMETS



PART #	CASE QTY	DESCRIPTION
B95227	24	Display Pack - Grommet for 4" round style lights
95227	100	Grommet for 4" round style lights

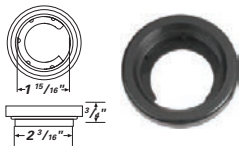

PART #	CASE QTY	DESCRIPTION
95208-1	400	Grommet for 2" sealed lights



PART #	CASE QTY	DESCRIPTION
95129	500	Mounting grommet



PART #	CASE QTY	DESCRIPTION
95208K	400	Display Pack - Grommet and plug, 2" lights
93875	500	Plug



PART #	CASE QTY	DESCRIPTION
95233	100	Grommet for 6" oval style lights



PART #	CASE QTY	DESCRIPTION
95208-3	200	Grommet for 2" sealed lights - closed back



PART #	CASE QTY	DESCRIPTION
95206-1	50	Grommet for 2 1/2" sealed lights



PART #	CASE QTY	DESCRIPTION
B95206K	24	Display Pack - Grommet and plug for 2 1/2" lights
93875	500	Plug
95206K	200	Grommet and plug for 2 1/2" lights

TECHNICAL REFERENCE



The following information is provided by the National Highway Traffic Safety Administration. Each diagram will show the specific requirements for that vehicle type.

Every lamp, reflex reflector, and conspicuity treatment (device) must be permanently attached in the location specified on the following pages and must comply with all applicable requirements prescribed for it by FMVSS/CMVSS 108. The face of any device on the front/rear and sides should be, respectively perpendicular and parallel to vehicle centerline, unless it is photometrically certified at installation angle.

In Canada: Manufacturers and importers of vehicles must have the proper certification test records demonstrating compliance of lighting components with all prescribed requirements.

TECHNICAL REFERENCE

DESCRIPTION				MANDATORY REQUIREMENTS			
AREA	EQUIPMENT	(SAE LENS CODING)	FUNCTIONAL PURPOSE	QUANTITY	COLOR	LOCATION	HEIGHT MM (IN.) FROM THE GROUND
1	TAIL LAMPS	(T)	INDICATE VEHICLE'S PRESENCE AND WIDTH	MINIMUM 2	RED	ON THE REAR - SYMMETRICAL - AS FAR APART AS PRACTICAL	380-1830 (15-72)
	STOP LAMPS	(S)	INDICATE BRAKING	MINIMUM 2	RED	ON THE REAR - SYMMETRICAL - AS FAR APART AS PRACTICAL	380-1830 (15-72)
	REAR TURN SIGNAL LAMPS	(I)	INDICATE DIRECTION OF TURN	MINIMUM 2	RED OR YELLOW	ON THE REAR - SYMMETRICAL - AS FAR APART AS PRACTICAL	380-2110 (15-83)
	REAR REFLEX REFLECTORS	(A)	INDICATE VEHICLE'S PRESENCE AND WIDTH	MINIMUM 2	RED	ON THE REAR - SYMMETRICAL - AS FAR APART AS PRACTICAL - FACING REARWARD	380-1530 (15 - 60)
2	LICENSE PLATE LAMP(S)	(L)	ILLUMINATES LICENSE PLATE	MINIMUM 1	WHITE	ON THE REAR - ABOVE OF A THE SIDES OF LICENSE PLATE	NO REQUIREMENT
3	REAR SIDE MARKER LAMPS	(P2, PC• OR P3, PC2*) *PHOTOMETRICALLY CERTIFIED AT INSTALLATION ANGLE		MINIMUM 2	RED	EACH SIDE AT REAR - AS FAR BACK AS PRACTICAL	380-1530 (15 - 60) NO MAX. FOR VEH. UNDER 2.032M(80") WIDE
	REAR SIDE REFLEX REFLECTORS	(A)		MINIMUM 2	RED	EACH SIDE AT REAR - AS FAR BACK AS PRACTICAL FACING SIDEWARD	380-1530 (15 - 60)
4A	FRONT SIDE MARKER LAMPS	(P2, PC• OR P3, PC2*) *PHOTOMETRICALLY CERTIFIED AT INSTALLATION ANGLE		MINIMUM 2	YELLOW	EACH SIDE AT FRONT - AS FAR FORWARD AS PRACTICAL	380 (15) MINIMUM
4B	FRONT SIDE REFLEX REFLECTORS	(A)		MINIMUM 2	YELLOW	EACH SIDE AT FRONT - AS FAR FORWARD AS PRACTICAL	380-1530

ADDITIONAL EQUIPMENT FOR TRAILERS EXCEEDING THE FOLLOWING PARAMETERS

LENGTH 9.1 M (30') OR LONGER

DESCRIPTION				MANDATORY REQUIREMENTS			
AREA	EQUIPMENT	(SAE LENS CODING)	FUNCTIONAL PURPOSE	QUANTITY	COLOR	LOCATION	HEIGHT MM (IN.) FROM THE GROUND
5A	INTERMEDIATE SIDE MARKET LAMPS	(P2 OR P3)	INDICATE PRESENCE OF A LONG VEHICLE	MINIMUM 2	YELLOW	EACH SIDE NEAR CENTER - FACING SIDEWARD	380 (15) MINIMUM
5B	INTERMEDIATE SIDE REFLEX REFLECTORS	(A)	INDICATE PRESENCE OF A LONG VEHICLE	MINIMUM 2	YELLOW	EACH SIDE NEAR CENTER - FACING SIDEWARD	380-1530 (15-60)

WIDTH 2.032 M (80 IN.) OR WIDER

DESCRIPTION				MANDATORY REQUIREMENTS			
AREA	EQUIPMENT	(SAE LENS CODING)	FUNCTIONAL PURPOSE	QUANTITY	COLOR	LOCATION	HEIGHT MM (IN.) FROM THE GROUND
6	REAR CLEARANCE LAMPS	(P2, PC• OR P3, PC2*) *PHOTOMETRICALLY CERTIFIED AT INSTALLATION ANGLE	SHOW VEHICLE'S WIDTH - MAY NOT BE COMBINED WITH TAIL LAMPS	MINIMUM 2	RED	AT WIDEST POINT - SYMMETRICAL - ON THE REAR OR NEAR THE REAR - FACING REARWARD	AS HIGH AS PRACTICAL - MAY BE LOWER ONLY IF ID LAMPS ARE AT THE TOP
7	REAR IDENTIFICATION LAMPS	(P2 OR P3)	INDICATE PRESENCE OF A WIDE VEHICLE	EXACTLY 3	RED	ON THE REAR - CENTER, FACING REARWARD - HORIZONTALLY SPACED 150MM (6 IN.) TO 300MM (12 IN.) APART	IN CANADA: AT THE TOP - MAYBE LOWER IF DOOR HEADER NARROWER THAN 25MM. IN USA: AS HIGH AS PRACTICAL
8	FRONT CLEARANCE LAMPS	(P2, PC• OR P3, PC2*) *PHOTOMETRICALLY CERTIFIED AT INSTALLATION ANGLE	SHOW VEHICLE'S WIDTH	MINIMUM 2	YELLOW	AT WIDEST POINT - SYMMETRICAL - AS FAR FORWARD AS PRACTICAL - FACING FORWARD	AS HIGH AS PRACTICAL

WIDTH 2.032 M (80 IN.) OR WIDER AND GVWR 4536 KG (10,000 LB.) OR MORE

DESCRIPTION				MANDATORY REQUIREMENTS			
AREA	CONSPICUITY TREATMENT	DOT CODING	QUANTITY	COLOR	LOCATION	HEIGHT	OPTIONS
9	REAR UPPER BODY MARKING		EXACTLY 2 PAIRS OF 300MM LONG STRIPS	WHITE	ON THE REAR UPPER CORNERS - FACING REARWARD	AT THE TOP	REFLEX REFLECTORS MAY NOT BE REQUIRED IF THE ARE REPLACED, IN THEIR REQUIRED LOCATION, WITH CONSPICUITY TREATMENT-----OPTIONAL IN CANADA REAR LOWER BODY AND SIDE CONSPICUITY TREATMENT MAY ALSO BE SOLID WHITE, SOLID YELLOW, OR WHITE AND YELLOW.
10	BUMPER BAR MARKING		CONTINUOUS	RED/WHITE	ON THE REAR BUMPER BAR'S HORIZONTAL ELEMENT - FULL WIDE - FACING REARWARD	NO REQUIREMENT	
11	REAR LOWER BODY MARKING		CONTINUOUS	RED/WHITE SEE OPTIONS	ON THE REAR - FULL WIDTH OF THE VEHICLE - FACING REARWARD	AS HORIZONTAL AS PRACTICAL AND AS CLOSE AS PRACTICAL TO THE RANGE OF 375 TO 1525 MM FROM THE GROUND	
12	SIDE MARKING		SEE LOCATION	RED/WHITE SEE OPTIONS	EACH SIDE - FACING SIDEWARD - CONTINUOUS, OR EVENLY SPACED OVER MINIMUM OF 50% OF LENGTH, STARTS AND ENDS AS CLOSE TO THE FRONT AND REAR OF VEHICLE AS PRACTICAL.	AS HORIZONTAL AS PRACTICAL AND AS CLOSE AS PRACTICAL TO THE RANGE OF 375 TO 1525 MM FROM THE GROUND	

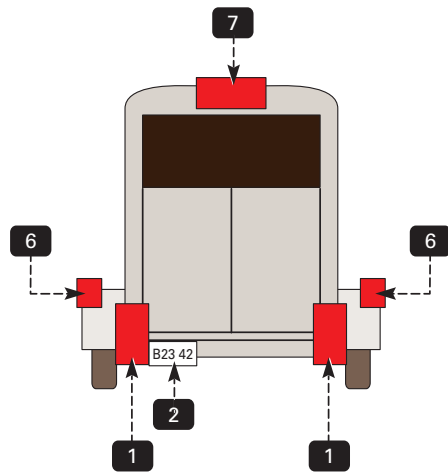
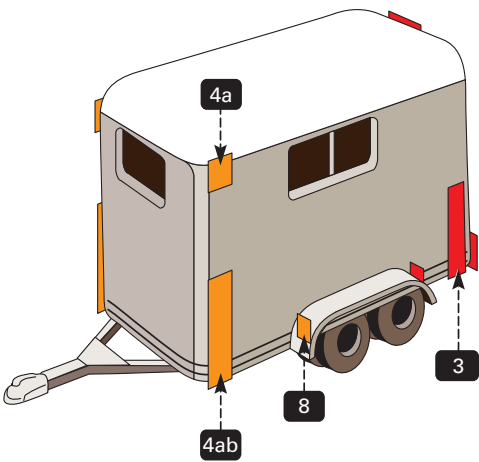
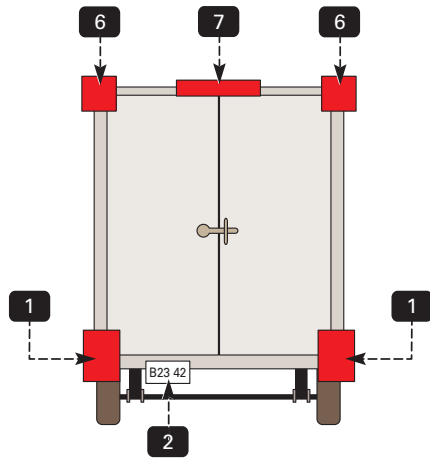
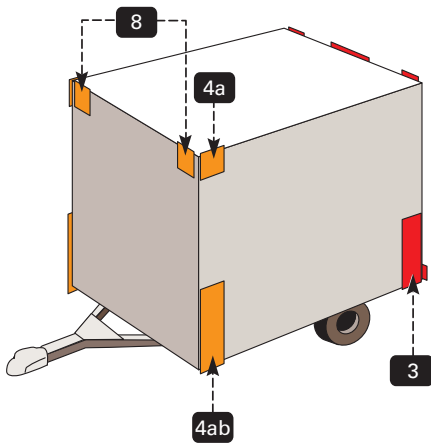
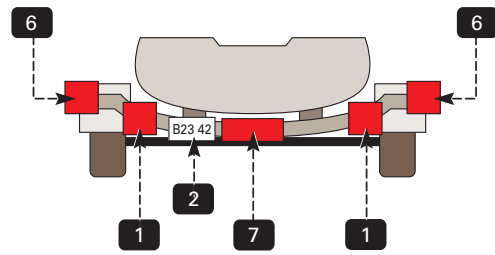
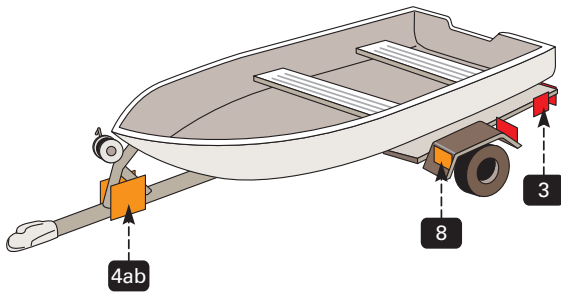
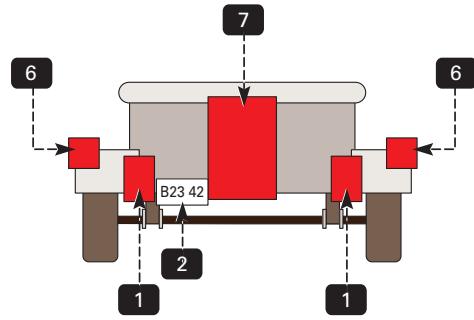
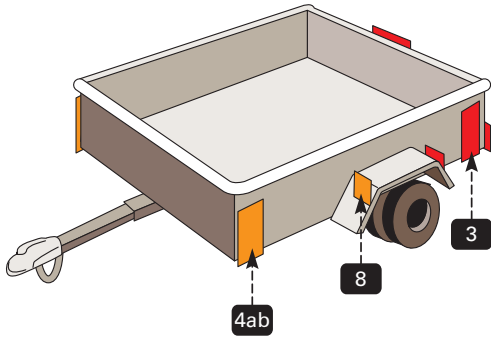

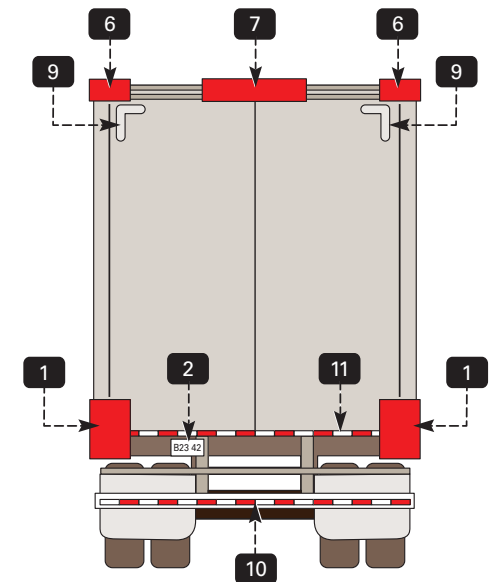
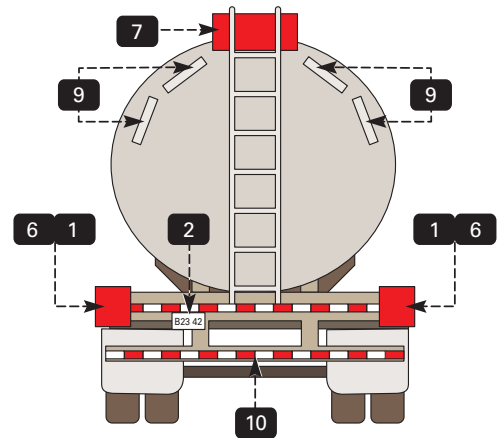
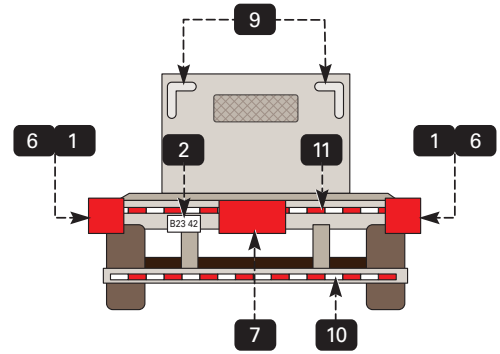
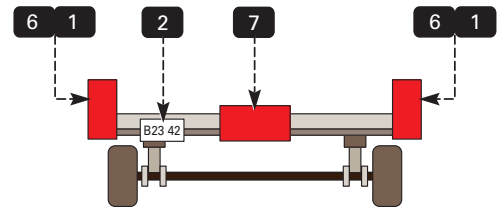
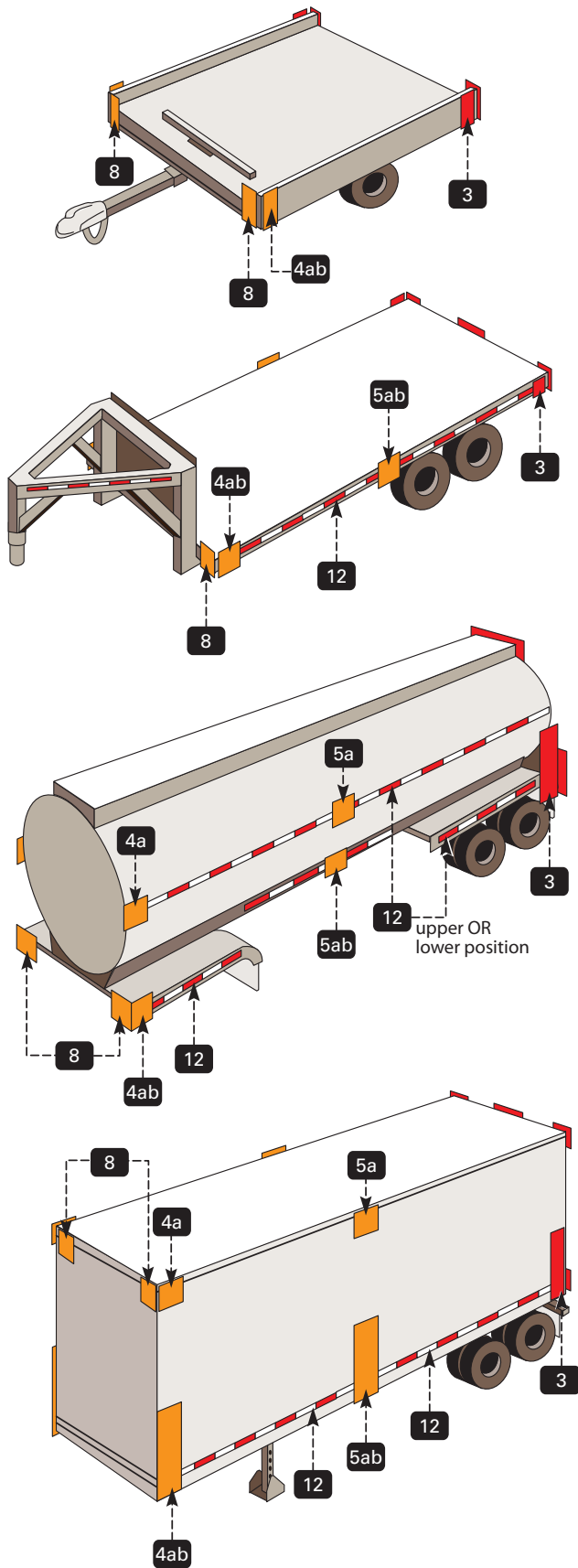

BASIC EQUIPMENT REQUIRED ON ALL TRUCKS, BUSES AND MPVS

DESCRIPTION				MANDATORY REQUIREMENTS			
AREA	EQUIPMENT	(SAE LENS CODING)	FUNCTIONAL PURPOSE	QUANTITY	COLOR	LOCATION	HEIGHT MM (IN.) FROM THE GROUND
1	HEADLAMPS -LOWER BEAM	(H, Hr) ATTENTION: US: "Dot" LETTERING REQUIRED ON LENS ATTENTION: US & CANADA: LIGHT SOURCE CODE REQUIRED ON LENS	FORWARD ROAD ILLUMINATION	MINIMUM 2	WHITE	ON THE FRONT - SYMMETRICAL - AS FAR APART AS PRACTICABLE (IF 4 LAMP SYSTEM - OUTBOARD OR ABOVE UPPER BEAMS)	560-1370 (22-54)
	HEADLAMPS -UPPER BEAM	H, Hr) ATTENTION: US: "Dot" LETTERING REQUIRED ON LENS ATTENTION: US & CANADA: LIGHT SOURCE CODE REQUIRED ON LENS	FORWARD ROAD ILLUMINATION	MINIMUM 2	WHITE	ON THE FRONT - SYMMETRICAL - AS FAR APART AS PRACTICABLE (IF 4 LAMP SYSTEM - OUTBOARD OR ABOVE UPPER BEAMS)	560-1370 (22-54)
	PARKING LAMPS ATTENTION: REQUIRED ONLY ON VEHICLES LESS THAN 2032MM WIDE	(P)	INDICATE PARKED VEHICLE	MINIMUM 2	WHITE OR YELLOW	FRONT - SYMMETRICAL - AS FAR APART AS PRACTICABLE	380-1530 (15-60)
	DAYTIME RUNNING LAMPS ATTENTION: FOR CANADA REQUIRED, FOR US OPTIONAL.	(Y2) ATTENTION: FOR US, "DRL" LETTERING REQUIRED ON LENS IF DEVICE IS NOT HEADLAMP	INDICATE IN-USE VEHICLE	MINIMUM 2	WHITE OR YELLOW	FRONT - SYMMETRICAL - AS FAR APART AS PRACTICABLE	380 (15) MINIMUM MAXIMUM DEPENDS ON TYPE OF DRL
	FRONT TURN SIGNAL/HAZARD WARNING LAMPS	(L)	INDICATE DIRECTION OF TURN / IDENTIFY DISABLED VEHICLE	MINIMUM 2	YELLOW	FRONT - SYMMETRICAL - AS FAR APART AS PRACTICABLE	380-2110 (15-83)
2	FRONT CLEARANCE LAMPS- ATTENTION: REQUIRED FOR VEHICLES 2032MM WIDE OR WIDER	(P2, Pc* Or P3*, Pc2) *PHOTOMETRICALLY CERTIFIED AT INSTALLATION ANGLE	SHOW VEHICLE'S WIDTH	MINIMUM 2	YELLOW	AT WIDEST POINT - SYMMETRICAL - ON THE FRONT OR NEAR THE FRONT - FACING FORWARD	AS HIGH AS PRACTICABLE
3	FRONT IDENTIFICATION LAMPS (Id)	(P2 Or P3)	INDICATE PRESENCE OF A WIDE VEHICLE	EXACTLY 3	YELLOW	ON THE FRONT - CENTER - HORIZONTALLY SPACED 150 MM (6 IN.) TO 50 MM (2 IN.) APART	AS HIGH AS PRACTICABLE OR ON TOP OF CAB
4A	FRONT SIDE MARKER LAMPS	(P2, Pc* Or P3, Pc2*) *PHOTOMETRICALLY CERTIFIED AT INSTALLATION ANGLE		MINIMUM 2	YELLOW	EACH SIDE AT FRONT - AS FAR FORWARD AS PRACTICABLE	380 (15) MINIMUM
4B	FRONT SIDE REFLEX REFLECTORS	(A)	FRONT AND REAR SIDE MARKER LAMPS / SIDE	MINIMUM 2	YELLOW	AT FRONT - SYMMETRICAL - AS FAR FORWARD AS PRACTICABLE - FACING SIDEWARD	380-1530 (15-60)
5A	REAR SIDE MARKER LAMPS **	(P2, Pc* Or P3, Pc2*) *PHOTOMETRICALLY CERTIFIED AT INSTALLATION ANGLE	REFLEX REFLECTOR INDICATE VEHICLE'S PRESENCE AND LENGTH	MINIMUM 2	RED	EACH SIDE AT REAR - AS FAR BACK AS PRACTICABLE	380 (15) MINIMUM
5B	REAR SIDE REFLEX REFLECTORS** ** NOT REQUIRED ON TRUCK TRACTORS	(A)		MINIMUM 2	RED	EACH SIDE AT REAR - AS FAR BACK AS PRACTICABLE - FACING SIDEWARD	380-1530 (15-60)
6	REAR CLEARANCE LAMPS ATTENTION: REQUIRED FOR VEHICLES 2032MM WIDE OR WIDER, BUT NOT REQUIRED ON TRUCK TRACTORS	(P2, Pc* Or P3, Pc2*) *PHOTOMETRICALLY CERTIFIED AT INSTALLATION ANGLE	SHOW VEHICLE'S WIDTH - MAY NOT BE COMBINED WITH TAIL LAMPS	MINIMUM 2	RED	AT WIDEST POINT - SYMMETRICAL - ON THE REAR OR NEAR THE REAR - FACING REARWARD	AS HIGH AS PRACTICABLE - MAY BE LOWER ONLY IF REAR ID LAMPS ARE AT THE TOP
7	REAR IDENTIFICATION LAMPS (Id) ATTENTION: REQUIRED FOR VEHICLES 2032MM WIDE OR WIDER, BUT NOT REQUIRED ON TRUCK TRACTORS	(P2 Or P3)	INDICATE PRESENCE OF A WIDE VEHICLE	EXACTLY 3	RED	REAR - CENTER - HORIZONTALLY SPACED 150 MM (6 IN.) TO 50 MM (2 IN.) APART, FACING REARWARD	IN CANADA : AT THE TOP - MAYBE LOWER IF DOOR HEADER NARROWER THAN 25 MM IN USA: AS HIGH AS PRACTICABLE
8	TAIL LAMPS	(T)	INDICATE VEHICLE'S PRESENCE AND WIDTH	MINIMUM 2	RED	ON THE REAR - SYMMETRICAL - AS FAR APART AS PRACTICABLE	380-1830 (15-72)
	STOP LAMPS	(S)	INDICATE BRAKING	MINIMUM 2	RED	ON THE REAR - SYMMETRICAL - AS FAR APART AS PRACTICABLE	380-1830 (15-72)
	REAR TURN SIGNAL/HAZARD WARNING LAMPS	(I)	INDICATE DIRECTION OF TURN/ IDENTIFIES DISABLED VEHICLE	MINIMUM 2	RED OR YELLOW	ON THE REAR - SYMMETRICAL - AS FAR APART AS PRACTICABLE	380-2110 (15-83)
	REAR REFLEX REFLECTORS	(A)	SHOW VEHICLE'S PRESENCE AND WIDTH	MINIMUM 2	RED	ON THE REAR - SYMMETRICAL - AS FAR APART AS PRACTICABLE - FACING REARWARD	380-1530 (15-60)
9	BACKUP LAMP	(R)	ILLUMINATE GROUND BEHIND THE VEHICLE AND ALERT ROAD USERS	MINIMUM 1	WHITE	REAR	NO REQUIREMENT
10	LICENSE PLATE LAMP(S)	(L)	ILLUMINATES LICENSE PLATE	MINIMUM 1	WHITE	ON THE REAR - ABOVE OR AT THE SIDES OF LICENSE PLATE	NO REQUIREMENT
11	CENTER HIGH MOUNTED STOP LAMP ATTENTION: REQUIRED FOR VEHICLES LESS THAN 2032MM WIDE AND 4536KG	(U3)	INDICATES BRAKING	MINIMUM 1	RED	ON THE REAR - CENTERLINE OF THE VEHICLE	860 (34) MINIMUM

ADDITIONAL EQUIPMENT FOR TRAILERS EXCEEDING THE FOLLOWING PARAMETERS

LENGTH 9.1 m (30') OR LONGER

DESCRIPTION				MANDATORY REQUIREMENTS			
AREA	EQUIPMENT	(SAE LENS CODING)	FUNCTIONAL PURPOSE	QUANTITY	COLOR	LOCATION	HEIGHT MM (IN.) FROM THE GROUND
12A	INTERMEDIATE SIDE MARKER LAMPS	(P2 OR PC)	INDICATE PRESENCE OF A LONG VEHICLE	MINIMUM 2	YELLOW	EACH SIDE NEAR CENTER	380 (15) MINIMUM
12B	INTERMEDIATE SIDE REFLEX REFLECTORS	(A)	INDICATE PRESENCE OF A LONG VEHICLE	MINIMUM 2	YELLOW	EACH SIDE NEAR CENTER - FACING SIDEWARD	380-1530 (15-60)

TRUCK TRACTORS

DESCRIPTION			MANDATORY REQUIREMENTS				OPTIONS
AREA	CONSPICUITY TREATMENT	DOT CODE	QUANTITY	COLOR	LOCATION	HEIGHT MM (IN.) FROM THE GROUND	
13	REAR UPPER BODY MARKING	DOT-C, DOT-C2, DOT-C3, OR DOT-C4	EXACTLY 2 PAIRS OF 50 MM LONG STRIPS	WHITE	REAR UPPER CORNERS OF CAB - FACING REARWARD	AS HIGH AS PRACTICABLE EXCLUDING FAIRINGS	
14	REAR MARKING	DOT-C, DOT-C2, DOT-C3, OR DOT-C4	EXACTLY 2 SECTIONS OF MIN. 600 MM EACH	RED/WHITE	REAR - FACING REARWARD - ON FENDERS, ON MUD FLAPS BRACKETS, OR WITHIN 50 MM BELOW OF THE TOP OF MUD FLAPS	AS HORIZONTAL AS PRACTICABLE AND NOT HIGHER THAN 1525 MM FROM THE GROUND	IF MUD FLAPS NOT USED - ON THE CAB OR FRAME MOUNTED BRACKETS

IMPORTANT NOTE:

EVERY LAMP, REFLEX REFLECTOR, AND CONSPICUITY TREATMENT (DEVICE) MUST BE PERMANENTLY ATTACHED IN THE LOCATION SPECIFIED BELOW AND MUST COMPLY WITH ALL APPLICABLE REQUIREMENTS PRESCRIBED FOR IT BY **FMVSS/CMVSS 108**. THE FACE OF ANY DEVICE ON THE FRONT/REAR AND SIDES SHOULD BE, RESPECTIVELY PERPENDICULAR AND PARALLEL TO VEHICLE CENTERLINE, UNLESS IT IS PHOTOMETRICALLY CERTIFIED AT INSTALLATION ANGLE. NO PART OF THE VEHICLE SHALL PREVENT ANY DEVICE FROM MEETING ITS PRESCRIBED REQUIREMENTS UNLESS AN AUXILIARY DEVICE MEETING ALL PRESCRIBED REQUIREMENTS IS INSTALLED.

IN CANADA: MANUFACTURERS AND IMPORTERS OF VEHICLES MUST HAVE THE PROPER CERTIFICATION TEST RECORDS DEMONSTRATING COMPLIANCE OF LIGHTING COMPONENTS WITH ALL PRESCRIBED REQUIREMENTS.

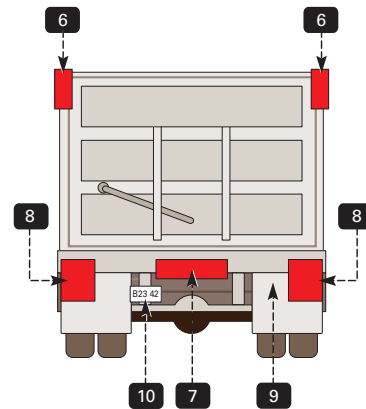
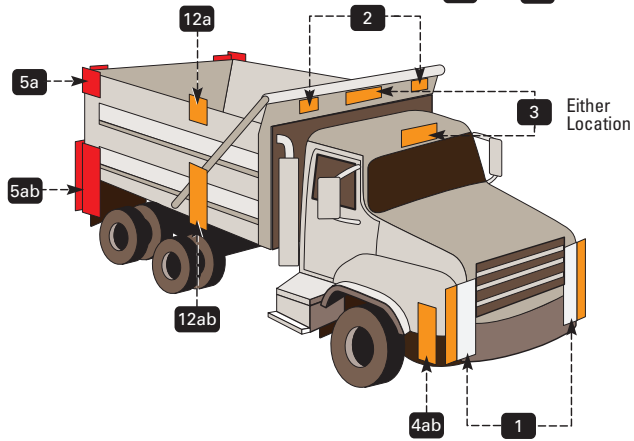
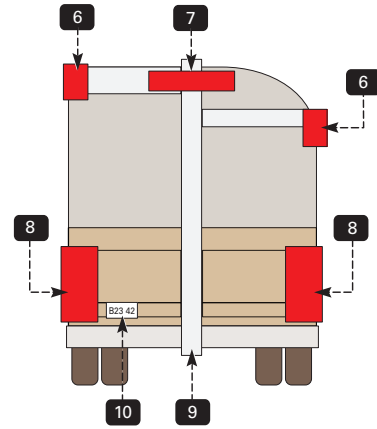
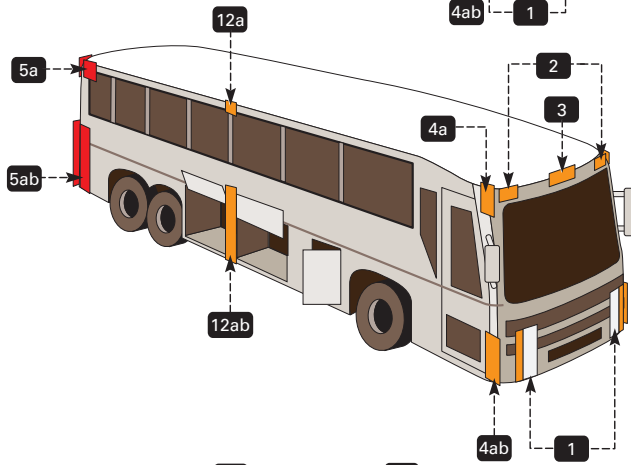
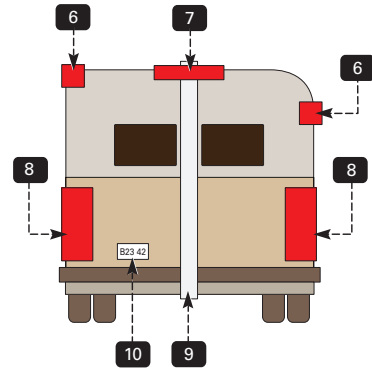
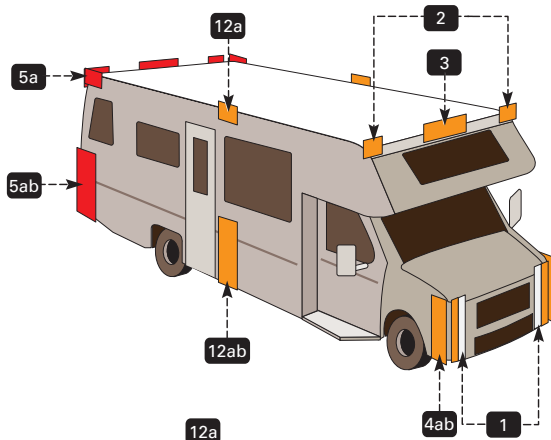
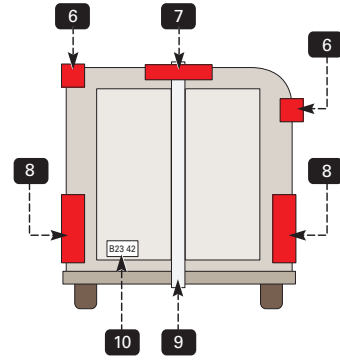
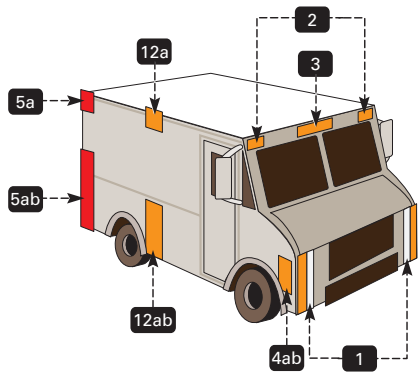

TECHNICAL REFERENCE

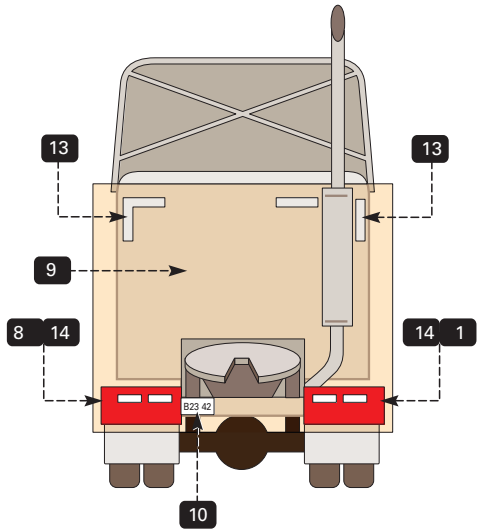
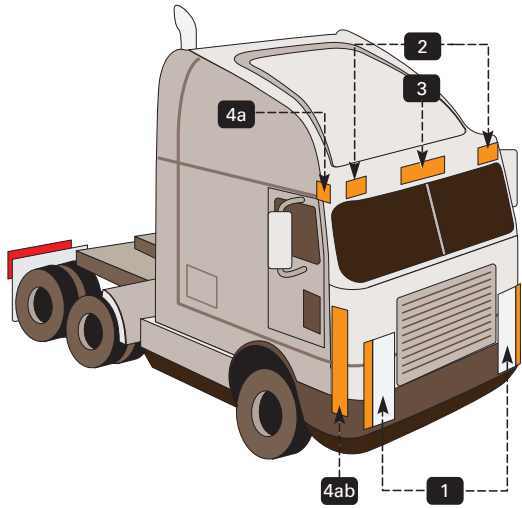
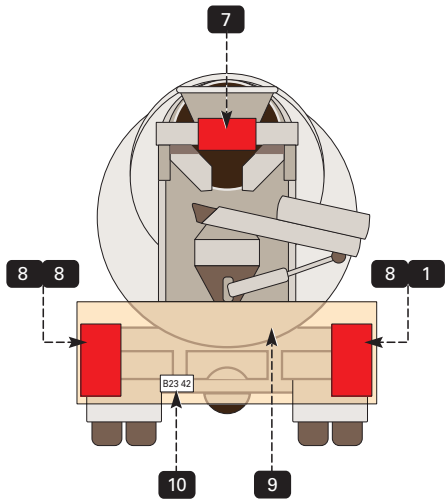
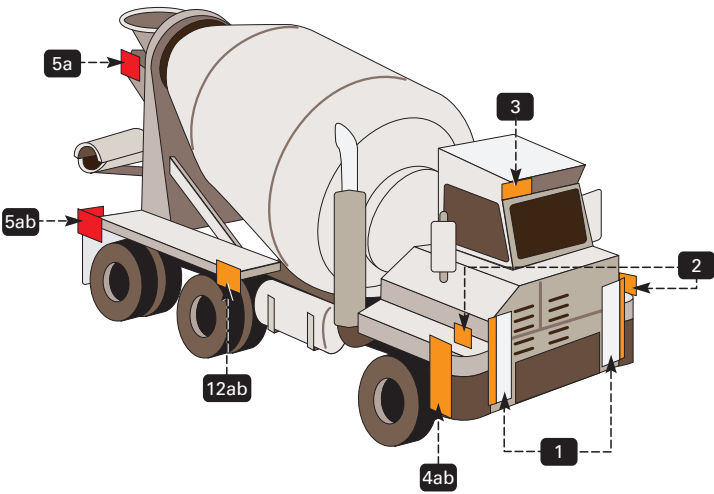
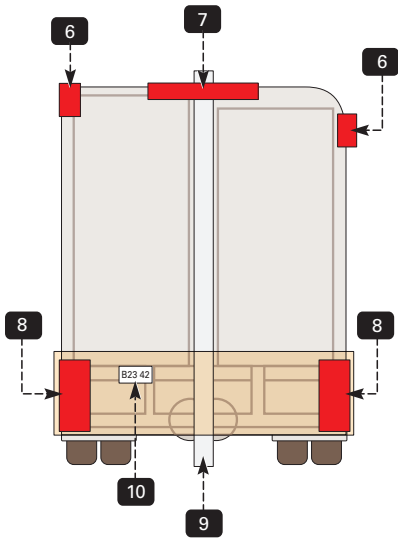
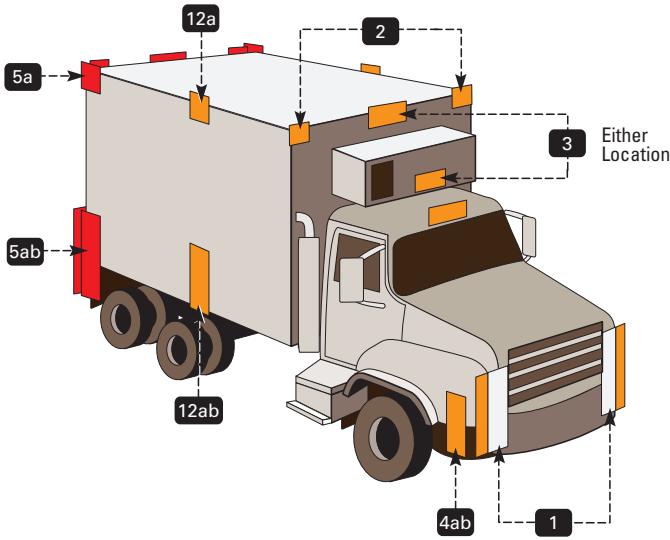

SAE DEVICE CODES

A	REFLEX REFLECTOR
A2	REFLEX REFLECTOR FOR USE ON VEHICLES 2032MM OR MORE IN OVERALL WIDTH
A3	REFLEX REFLECTOR FOR CONSPICUITY TREATMENT (CT), FOR USE ON VEHICLES 2032MM OR MORE IN OVERALL WIDTH
A4	REFLEX REFLECTOR FOR CT (VEHICLES > 2032MM IN WIDTH) - 50MM WIDE [TRUCK/TRAILER]
A5	REFLEX REFLECTOR FOR CT (VEHICLES > 2032MM IN WIDTH) - 75MM WIDE [TRUCK/TRAILER]
A6	REFLEX REFLECTOR FOR CT (VEHICLES > 2032MM IN WIDTH) - 100MM WIDE [TRUCK/TRAILER]
A7	REFLEX REFLECTOR FOR CT (VEHICLES > 2032MM IN WIDTH) - 25MM WIDE [TRUCK/TRAILER]
C	MOTORCYCLE AUXILIARY FRONT LAMP
D	MOTORCYCLE AND MOTOR-DRIVEN CYCLE TURN SIGNAL LAMP
DL	DISTRIBUTED LIGHTING SYSTEM (HEADLAMP)
E	SIDE TURN SIGNAL LAMP - VEHICLES 12M OR MORE IN LENGTH
E2	SIDE TURN SIGNAL LAMP - VEHICLES LESS THAN 12M IN LENGTH
EVS1	SIREN - INTERIOR LOCATION
EVS2	SIREN - EXTERIOR LOCATION
EVS3	SIREN - UNDER HOOD LOCATION
F	FRONT FOG LAMP
F2	FOG TAIL LAMPS
G	TRUCK CARGO LAMP
H	SEALED BEAM HEADLAMP
HC	HEADLAMP CENTER
HG	DISCHARGE FORWARD LIGHTING (HEADLAMP)
HH	SEALED BEAM HEADLAMP HOUSING
HR	REPLACEABLE BULB HEADLAMP
I	TURN SIGNAL LAMP SPACED GREATER THAN 100MM FROM HEADLAMP
I3	TURN SIGNAL LAMP SPACED FROM 75MM TO LESS THAN 100MM FROM HEADLAMP
I4	TURN SIGNAL LAMP SPACED FROM 60MM TO LESS THAN 75MM FROM HEADLAMP
I5	TURN SIGNAL LAMP SPACED LESS THAN 60MM FROM HEADLAMP
I6	REAR MOUNTED TURN SIGNAL LAMP AND FRONT MOUNTED TURN SIGNAL LAMPS MOUNTED 100MM OR MORE FROM THE HEADLAMP, FOR USE ON VEHICLES 2032MM OR MORE IN OVERALL WIDTH
I7	FRONT MOUNTED TURN SIGNAL LAMP MOUNTED LESS THAN 100MM FROM THE HEADLAMP, FOR USE ON VEHICLES 2032MM OR MORE IN OVERALL WIDTH
J1690	FLASHER
K	FRONT CORNERING LAMP
K2	REAR CORNERING LAMP
L	LICENSE PLATE LAMP
M	MOTORCYCLE AND MOTOR-DRIVEN CYCLE HEADLAMP - MOTORCYCLE TYPE
N	MOTORCYCLE AND MOTOR-DRIVEN CYCLE HEADLAMP - MOTOR-DRIVEN CYCLE TYPE
O	SPOT LAMP
P	PARKING LAMP
P2	SIDE MARKER LAMP FOR USE ON VEHICLES 2032MM OR LESS IN OVERALL WIDTH
P3	CLEARANCE, SIDE MARKER AND IDENTIFICATION LAMP FOR USE ON VEHICLES 2032MM OR MORE IN OVERALL WIDTH
PC2	COMBINATION CLEARANCE AND SIDE MARKER LAMP FOR USE ON VEHICLES 2032MM OR MORE IN OVERALL WIDTH

SAE DEVICE CODES

Q	TURN SIGNAL OPERATING UNIT - CLASS A
QB	TURN SIGNAL OPERATING UNIT - CLASS B
QC	VEHICULAR HAZARD WARNING SIGNAL OPERATING UNIT
QD1	TURN SIGNAL OPERATING UNIT FOR USE ON VEHICLES 2032MM OR MORE IN OVERALL WIDTH - TYPE 1
QD2	TURN SIGNAL OPERATING UNIT FOR USE ON VEHICLES 2032MM OR MORE IN OVERALL WIDTH - TYPE 2
QE1	HAZARD WARNING OPERATING UNIT FOR USE ON VEHICLES 2032MM OR MORE IN OVERALL WIDTH - TYPE 1
QE2	HAZARD WARNING OPERATING UNIT FOR USE ON VEHICLES 2032MM OR MORE IN OVERALL WIDTH - TYPE 2
R	REVERSING (BACK-UP) LAMP
S	STOP LAMP
S2	STOP LAMP FOR USE ON VEHICLES 2032MM OR MORE IN OVERALL WIDTH
T	TAIL LAMP (REAR POSITION LAMP)
T2	TAIL LAMP (REAR POSITION LAMP) FOR USE ON VEHICLES 2032MM OR MORE IN OVERALL WIDTH
U	SUPPLEMENT HIGH-MOUNTED STOP AND TURN SIGNAL LAMP
U2	HIGH-MOUNTED STOP LAMP FOR USE ON VEHICLES 2032MM OR MORE IN OVERALL WIDTH
U3	CENTER HIGH-MOUNTED STOP LAMP FOR PASSENGER CARS, LIGHT TRUCKS AND MPV'S
W	WARNING LAMP FOR EMERGENCY, MAINTENANCE AND SERVICE VEHICLES
W2	WARNING LAMP FOR SCHOOL BUSES
W3-1	OPTICAL WARNING DEVICE - CLASS 1
W3-2	OPTICAL WARNING DEVICE - CLASS 2
W3-3	OPTICAL WARNING DEVICE - CLASS 3
W4	EMERGENCY WARNING DEVICE [TRIANGULAR SHAPE]
W5-1	360° GASEOUS DISCHARGE LAMP - CLASS 1
W5-2	360° GASEOUS DISCHARGE LAMP - CLASS 2
W5-3	360° GASEOUS DISCHARGE LAMP - CLASS 3
X	ADAPTIVE [FORWARD] LIGHTING SYSTEM
Y	AUXILIARY HIGH BEAM LAMP
Y2	DAYTIME RUNNING LAMP
Z	AUXILIARY LOW BEAM LAMP

COURTESY SAE (SOCIETY OF AUTOMOTIVE ENGINEERS)

Product No	Page No	Product No	Page No	Product No	Page No	Product No	Page No
58BA	80	170B	72	382RDM-24	83	507BR	8
58BR	80	172B	72	384CDM	83	507BRK	8
58SA	80	174B	72	384CDM-24	83	508BA	9
58SR	80	175B	71	392SB	75	508BR	9
68BA	81	176B	72	394SB	74	513BR	13
68BR	81	178B	73	396SB	73	514BR	13
80B	38	188SA	79	398SB	74	523BA	11
82B	37	188SR	79	423BA	32	529BA	16
83QB	37	322BA	12	423BR	32	529BAK	16
84QB	38	322BAK	12	429BA	31	531AK	12
85BA	40	322BR	12	480BA	30	531AR	12
85BR	40	322BRK	12	480BR	30	531BAK	12
85BRK	40	323WBA	11	483BA	29	531BARK	12
87B	39, 43	323WBR	11	483BR	29	531BRK	12
88BA	81	372ODM	83	485BA	30	531RK	12
88BR	81	372ODM-24	83	485BC	30	533BA	9
89BA	80	376BDM	82	486BA	33	533BAK	9
89BR	80	376BDM-8	82	486BR	33	533BR	9
90B	38	376BDM-24	82	488BA	31	533BRK	9
90BA	81	376RDM	82	488BAKB	31	534BAK	7
90BR	81	376RDM-8	82	488BAR	31	534BAK2B	7
92B	37	376RDM-24	82	488BARKB	31	534BBK	76
93QB	37	377RDM	83	488BRKB	31	534BCK	76
94QB	38	377RDM-24	83	490BA	30	534BCK2B	76
95BC	76	379RDM	82	504BA	8	534BGK	76
95BRK	39	379RDM-24	82	504BR	8	534BRK	7
97B	39, 43	381ODM	83	505BAK	8	534BRK2B	7
158B	71	381ODM-4	83	505BRK	8	534CAK	7
159B	71	381ODM-24	83	506BA	9	534CBAK	7
160B	71	381ODM-72	83	506BAK	9	534CBRK	7
168B	73	381YDM	83	506BR	9	534CRK	7
168SA	79	381YDM-24	83	506BRK	9	536BA	10
168SR	79	381YDM-72	83	507BA	8	536BAKB	10
169B	72	382RDM	83	507BAK	8	536BR	10

NUMERICAL INDEX

Product No	Page No	Product No	Page No	Product No	Page No	Product No	Page No
536BRKB	10	915BR	40	92536BK	30, 89	B80	38, 43
539BA	11	915BRK	40	93029	90	B83	37, 44
539BR	11	3483BR	35	93203	90	B84	38, 44
542BC	77	3485BR	34	93549	17, 90	B85AK	40
542BR	17	3486BR	34	93721	30, 89	B85R	40
542BRK	17	3486R	34	93874	31, 40, 90	B85RK	40
545BR	17	3489R	34	93875	8, 9, 10, 30, 90, 91	B90	38, 43
546BR	17	3490R	13	93876	16, 17, 90	B93	37, 44
553BR	17	3490RC	13	95129	91	B94	38, 44
561BA	16	3491CR	15	95206-1	8, 91	B95	39
561BC	77	3491R	15	95206K	91	B95C	39, 76
561BR	16	3491RC	15	95208-1	91	B95S	39
561BRK	16	5441B	17	95208-3	91	B99SW	38
562BCR	16	5442B	17	95208K	91	B149	71
563BAK	15	5641B	16	95227	91	B160	71
563BR	15	5642B	16	95233	16, 31, 40, 91	B165	71
563BRK	15	6302	43	96101	89	B168	73
565BR	16	7288B	19	97563	15	B170	72
565BRK	16	7298B	19	97881	90	B178SAW	79
567-2R	41	7500	81	98534AR	7	B178SRW	79
588BA	10	9827A	27, 87	98534CAR	7	B192	89
588BR	10	9827R	27, 87	99534AR	7	B278SAW	79
710BA	17	91101C	87	99534CAR	7	B278SRW	79
710BR	17	91327BA	87	938741	90	B280A	82
783B	18	91327BR	87	938751	90	B280RW	82
784B	18	92129C	89	938761	90	B393S	74
793B	18	92204	89	AX4010K	53	B423A	32
794B	18	92227	89	AX4020K	54	B423R	32
836BA	27	92227-2C	89	AX4040K	53	B427A	31
836BR	27	92232B	12, 31, 89	AX4050K	54	B427R	31
838BA	27	92232BK	12, 31, 89	B38SA	80, 82	B430BLK	39
838BAK	27	92232C	12, 31, 89	B38SR	80, 82	B444A	29
838BR	27	92232CK	12, 31, 89	B38SRW	80, 82	B444R	29
838BRK	27	92233	89	B55UW	41	B450C	73

Product No	Page No	Product No	Page No	Product No	Page No	Product No	Page No
B452	75	B567-2R	41	B9423R	85	C129	69
B461	73	B666A	28	B9427A	86	C168	72
B465A	40	B666BL	28	B9427R	86	C223	67
B465R	40	B666C	28	B9444A	29, 86	C225	67
B472FA	33	B666R	28	B9444R	29, 86	C285RW	82
B478A	33	B669BU	75	B9460R	41, 86	C322A	12
B478R	33	B672UK	76	B9486A	33	C322R	12
B479A	32	B827A	27	B9486R	33	C323WBAK	11
B479R	32	B827R	27	B9487A	28, 86	C323WBRK	11
B480A	30	B836A	27	B9487R	28, 86	C393S	74
B480R	30	B836R	27	B9534AR2	7	C394S	75
B482TW2A	28	B838A	27	B9610A	28, 87	C396S	74
B482TW2R	28	B838R	27	B9610R	28, 87	C397S	75
B484W1A	29	B888A	80	B9899A	29, 87	C487CAK	34
B484W1R	29	B888R	80	B9899R	29, 87	C513R	13
B485A	30	B983	37, 85	B92232K	89	C514RW	13
B485R	30	B999R	38, 85	B92233	89	C523R	11
B486A	33	B1002R	41	B93874	39, 90	C525A	8
B486BL	33	B1003R	41	B95206K	91	C525R	8
B486CAK	33	B1004R	41	B95227	17, 39, 91	C526A	9
B486CRK	33	B1005R	41	B938751	90	C526R	9
B486R	33	B3485R	34	C38CAW	47	C534AK6	7
B487A	28	B3489A	34	C40AW	48	C534BAK	7
B487R	28	B3489R	34	C42A	48	C534BCK	76
B488A	31	B3552R	40	C43A	48	C534BRK	7
B488ARB	31	B4851A	30	C45AW	48	C534CK6	76
B488R	31	B4851R	30	C48AW	48	C534RK6	7
B495A	32	B9106A	85	C52CW	51	C535A	13
B499A	28	B9106R	85	C81	37, 44	C535R	13
B499R	28	B9216R	39, 40	C83PTM	20	C539A	11
B534A2	7	B9216R	85	C91	37, 44	C539R	11
B534R2	7	B9423A	32, 85	C93PTM	20	C542PTM	20
B567	41	B9423K	85	C123	67	C542RL	17
B567-1AA	41	B9423R	32	C125	67	C542RTM	17

NUMERICAL INDEX

Product No	Page No	Product No	Page No	Product No	Page No	Product No	Page No
C545RTM	17	C3078K	58	C8005W	67	CWL515	62
C561ATM	16	C3079K	62	C8006W	67	CWL518	58
C561PTM	20	C3079TW	62	C8007W	67	CWL524D	59
C561RL	16	C3080K	62	C8010	68	CWL524S	61
C561RTM	16	C3221A	12	C8011	68	CWL535	69
C562ATM	15	C3221R	12	C8014	68	CWL536D	59
C562CATM	16	C3490R	13	C8020	77	CWL536S	61
C562CRTM	16	C3491RC	15	C8050K	51	CWL552D	59
C562RTM	15	C4500AW	47	C8393PTM	20	CWL552S	61
C563RTM	15	C4845	49	CW523A	11	CWL610	63
C588A	10	C4850AW	47	CW1531A	12	CWL615	63
C588R	10	C4855AW	47	CW1531R	12	CWL620	63
C595A	11	C4855CAC	47	CW1536A	10	CWL622	63
C599SWTM	19	C4855CAW	47	CW1536R	10	CWL624	63
C789RTM	19	C5721	23	CW1544A	11	CWL625	64
C1534BAK	7	C6285	43	CW1544R	11	CWL626	64
C1534BCK	76	C6288	43	CW1586A	10	CWL627	59
C1534BRK	7	C6300	43	CW1586R	10	CWL630*	58
C2080	77	C6304	24	CW8002K	52	CWL631	58
C2534BAK	7	C6350	49	CWL113	60	CWL636	64
C2534BRK	7	C6350A	49	CWL118	60	CWL637	64
C3010K	63	C6355	49	CWL235	68	CWL638	64
C3015K	63	C6421	44	CWL503	68	CWL692	64
C3022K	59	C6423	44	CWL504	68	CWL51222	57
C3050K	63	C6423PTM	24	CWL505	69	CWL52450	57
C3062K	53	C6424	44	CWL506	69	DF472CAK	33
C3062KBL	53	C7280	23	CWL507	69	DF-880BP-2	55
C3067K	53	C7288TM	19	CWL508	69	DF1073KB	52
C3068K	58	C7298TM	19	CWL509	62	DF1075KB	52
C3071K	61	C7300	24	CWL510	62	DF1077KB	52
C3072K	61	C7423	23	CWL511	61	DF3619	51
C3073K	61	C7425	23	CWL512	61	DF-H10BP-2	54
C3073KFM	61	C7483RTM	18	CWL513	58	MM510	54
C3074K	62	C7493RTM	18	CWL514	62	N9002K	51

Product No	Page No	Product No	Page No	Product No	Page No	Product No	Page No
RE1088B	54	T178SA	79	T478BA	33	T888BR	80
T38SA	80, 82	T178SR	79	T478BR	33	T983B	37, 85
T38SR	80, 82	T182B	89	T484W1BA	29	T3552BR	40
T55SWB	41	T280C	81	T484W1BR	29	T5672AAB	41
T78SA	79	T280R	81	T485BA	30	T5672ARB	41
T78SR	79	T393SB	74	T485BR	30	V280C	81
T83B	37	T423BA	32	T488BA	31	V280R	81
T85BR	40	T430BLKB	39	T488BR	31		
T93B	37	T444BA	29	T495BA	32		
T95BR	39	T444BR	29	T888BA	80		

Blazer International is a proud member of:

